

xCORE VocalFusion 4-Mic Kit for Amazon AVS Hardware Manual

IN THIS DOCUMENT

- ▶ Features
 - ▶ Introduction
 - ▶ Clock sources and distribution
 - ▶ Stereo DAC with headphone amplifier
 - ▶ MEMS microphone board
 - ▶ I2C bus
 - ▶ General purpose user interface
 - ▶ Extension headers
 - ▶ USB port
 - ▶ Flash memory
 - ▶ xSYS connector
 - ▶ xCORE VocalFusion BaseBoard portmap
 - ▶ Operating requirements
 - ▶ Dimensions
 - ▶ RoHS and REACH
 - ▶ Schematics
-

The **xCORE VocalFusion 4-Mic Kit for Amazon AVS** is an application specific design targeted at far-field voice capture and processing for Amazon Alexa Voice Service (AVS) applications.

The kit is based on the XMOS XVF3000 voice processor and integrates the xCORE microphone capture and voice processing library with all the necessary hardware building blocks including:

- ▶ linear array of 4 omni-directional microphones
- ▶ low-jitter audio clock
- ▶ configurable user input buttons and LEDs
- ▶ I2S audio and I2C control connectivity
- ▶ optional USB2.0 device audio and control connectivity

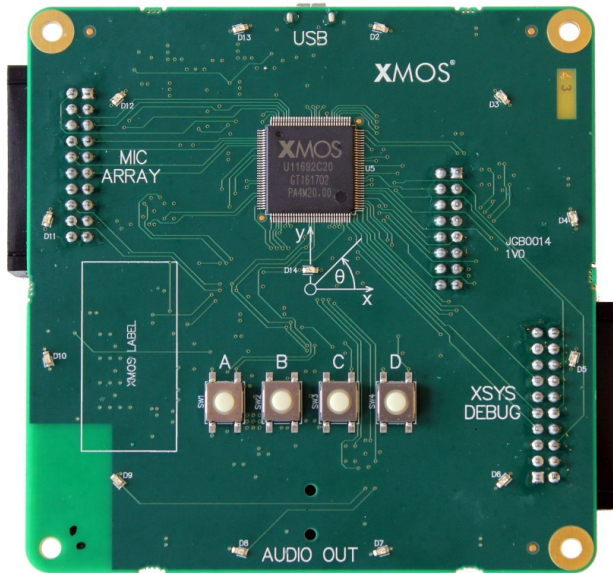

Figure 1:
xCORE
VocalFusion
BaseBoard



Figure 2:
xCORE
VocalFusion
Short Linear
microphone
board

1 Features

A block diagram for the **xCORE VocalFusion 4-Mic Kit for Amazon AVS** is shown in Figure 3 below. It includes:

- ▶ xCORE VocalFusion XVF3000 voice processor
- ▶ Four MEMS microphones (on a separate board)
- ▶ A micro-USB connector for power (and optionally USB2.0 device connectivity)
- ▶ An extension header for I2S audio and I2C control connectivity
- ▶ Four general purpose push-button switches (not currently used)
- ▶ 13 user-controlled LEDs (not currently used)
- ▶ Low-jitter audio clock source
- ▶ An xSYS connector for an xTAG debug adapter

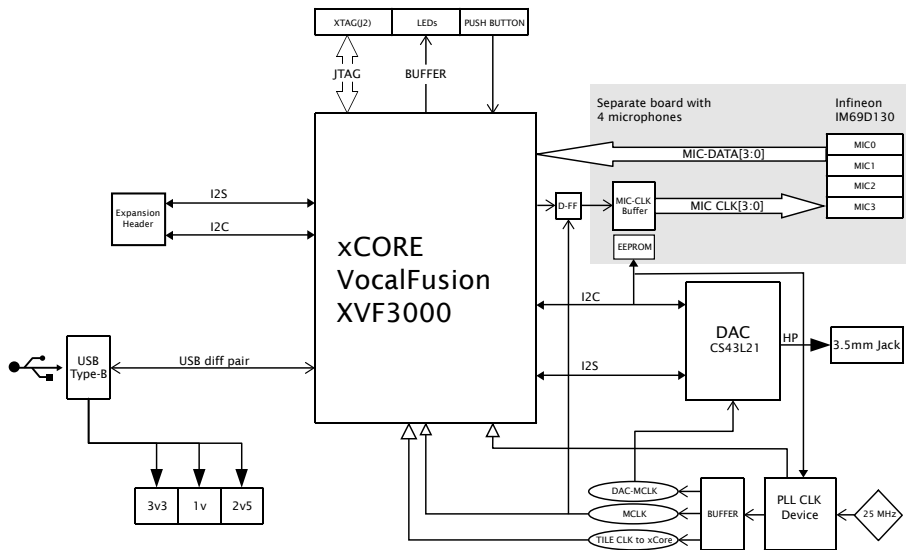

Figure 3:
xCORE
VocalFusion
4-Mic Kit for
Amazon AVS
block
diagram

2 Introduction

The **xCORE VocalFusion 4-Mic Kit for Amazon AVS** (XK-VF3000-L33-AVS) consists of an xCORE VocalFusion BaseBoard (XP-VF3000-BASE, Figure 1) and a separate linear microphone array (LINEAR MICROPHONE ARRAY E, Figure 2) using Infineon IM69D130¹ MEMS microphones.

The VocalFusion BaseBoard is based on the XMOS XVF3000 device, running a software which integrates the xCORE microphone capture and voice processing library to provide: beamforming, acoustic echo cancellation, noise suppression, de-reverberation and automatic gain control.

The XVF3000 device has 16 32-bit logical processing cores and integrates 2MBytes Quad Serial Peripheral Interface (QSPI) flash in a TQ128 package.

For general information on the XVF3000 device see the xCORE-200 Architecture Overview². For device specific information on the XVF3000 device see the XVF3000 Datasheet³.

¹<http://www.infineon.com/microphones>

²<http://www.xmos.com/published/xcore-architecture>

³http://www.xmos.com/published/xvf3000_3100-tq128-datasheet

3 Clock sources and distribution

The BaseBoard includes a single clock generator (Si5351A-B04486-GT, U25) that generates two clocks:

- ▶ XVF3000 reference clock - 24MHz oscillator
- ▶ Low jitter master audio clock - 24.576MHz oscillator, used for the DAC and (indirectly) the microphones

The clock generator is controlled over the I2C bus (see §6, below).

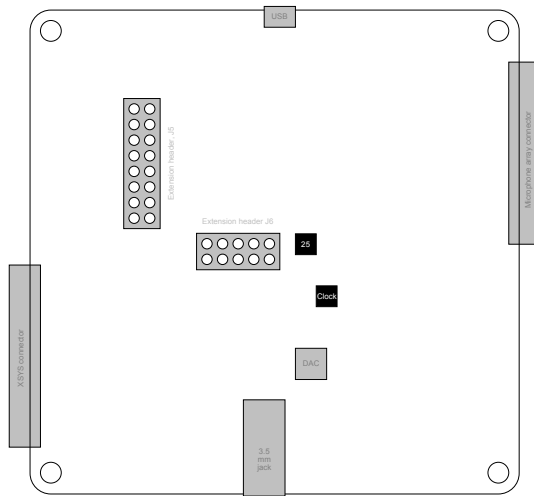

Figure 4:
Clock and
oscillator
locations

4 Stereo DAC with headphone amplifier

A CS43L21 stereo DAC with integrated headphone amplifier is used to generate audio output on a 3.5mm audio jack. The CS43L21 is connected to the XVF3000 device through an I2S interface and is configured using the I2C bus (see §6, below).

The CS43L21 stereo DAC/HPA device is connected to the following pins for its I2S interface:

Pin	Port	Signal
X1D28	P4F0	DAC_RST_N
X1D36	P1M0	I2S_BCLK
X1D37	P1N0	I2S_LRCK
X1D38	P1O0	MCLK_TILE1
X1D39	P1P0	I2S_DAC_DATA

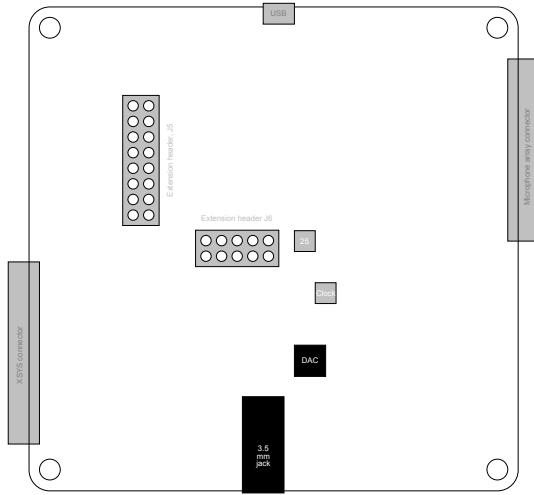

Figure 5:
DAC and
3.5mm audio
jack locations

5 MEMS microphone board

The microphone board is plugged into connector J3 on the BaseBoard using a ribbon cable. A short ribbon cable should be used for signal integrity.



The microphones should **not** be plugged into the xSYS connector.

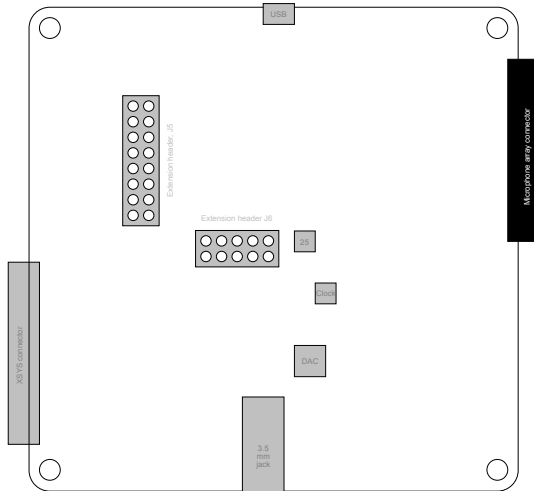

Figure 6:
Microphone
connector
location

The microphone array consists of a linear array of four microphones (spaced 33mm apart), a clock buffer, voltage level shifters and an EEPROM for optional identification.

The microphone signals are mapped onto the XVF3000 device as shown in Figure 7.

Microphone	xCORE GPIO	Port
MIC_CLK	X0D12	P1E0
MCLK_IN	X0D13	P1F0
MIC_0	X0D14	P8B0
MIC_1	X0D15	P8B1
MIC_2	X0D16	P8B2
MIC_3	X0D17	P8B3

Figure 7:
Linear MEMS
microphone
board xCORE
GPIO

6 I2C bus

The BaseBoard has a main I2C bus that is used to control the DAC, clock generator, and EEPROM. This main I2C bus is connected to tile 1 of the XVF3000, with the XVF3000 acting as a master on this I2C bus.

Pin	Port	Signal
X1D26	P4E0	I2C_SCL
X1D27	P4E1	I2C_SDA

The addresses of devices on the I2C bus are shown below.

Device	Address
Si5351A (Clock)	0b1100010 0x62
CS43L21 (DAC)	0b1001010 0x4A
24LC08B (EEPROM on microphone board)	0b1010Xxx 0x5x

Please refer to the 24LC08B datasheet for details on how to set the address of the EEPROM.

The BaseBoard also has a secondary I2C bus, on which the XVF3000 is a slave - so allowing the XVF3000 to be controlled by an external I2C host. This slave I2C interface is wired up to the extension header (see §8, below).

7 General purpose user interface

The BaseBoard has 13 LEDs that are controlled by the XVF3000 GPIO. LED_0 - LED_11 (D2-D13) are positioned around the edge of the BaseBoard. LED_12 (D14) is positioned in the middle of the BaseBoard. The LED GPIO output must be set low to light the corresponding LED.

Four general purpose push-button switches are provided. When pressed, each button creates a connection from the I/O to GND. To ensure correct behavior, the port connected to the buttons (P4A) must always be defined as an input.

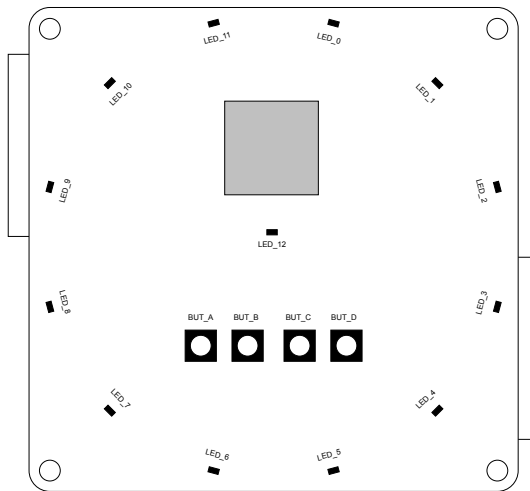

Figure 8:
General purpose user interface components

The signal mapping of the user interface components is shown in Figure 9 and Figure 10

UI signal	xCORE GPIO	Port
BUTTON_A	X0D02	P4A0
BUTTON_B	X0D03	P4A1
BUTTON_C	X0D08	P4A2
BUTTON_D	X0D09	P4A3

Figure 9:
User interface GPIO

A green LED (PGOOD) near the USB connector indicates 3V3 and 1V0 supplies are up.

UI signal	xCORE GPIO	Port
LED_0	X0D26	P16B0
LED_1	X0D27	P16B1
LED_2	X0D28	P16B2
LED_3	X0D29	P16B3
LED_4	X0D30	P16B4
LED_5	X0D31	P16B5
LED_6	X0D32	P16B6
LED_7	X0D33	P16B7
LED_8	X0D34	P1K0
LED_9	X0D35	P1L0
LED_10	X0D36	P16B8
LED_11	X0D37	P16B9
LED_12	X0D38	P16B10

Figure 10:
User interface
GPIO

8 Extension headers

The BaseBoard has a two extension headers, J5 and J6, containing: audio MCLK, all I2S signals, the secondary I2C bus (see §6) and seven general purpose IOs controlled by the XVF3000.

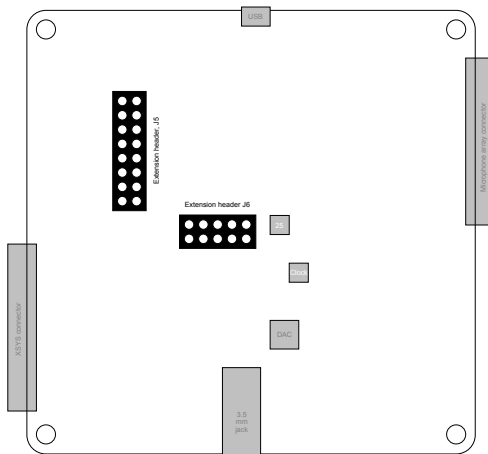

Figure 11:
Extension
header
location

The signal mapping of the extension header is shown in Figure 12 and Figure 13.

These signals allow the XVF3000 to be connected to an external applications processor host. In the following descriptions:

- ▶ *input* means captured voice audio that is sent from the XVF3000 to the host.
- ▶ *output* means audio sent from the host to the XVF3000, to be played out from the DAC.

The software pre-flashed in to the **xCORE VocalFusion 4-Mic Kit for Amazon AVS** configures the XVF3000 device and BaseBoard hardware to use these extension headers; to enable I2S audio input/output connectivity (XVF3000 is the I2S master) and I2C control (XVF3000 is an I2C slave).

- ▶ XVF3000 as I2S master

Audio input and output connectivity is provided via I2S, via pins 1, 3, 6 of J6 and pin 4 of J5.

I2S_DAC_DATA is the audio output from the host for the DAC far-end signal.

I2S_ADC_DATA is the audio input to the host from the XVF3000.

MasterClock is generated by the XVF3000 and provided on pin 7 of J6 for connection to the host.

- ▶ XVF3000 as I2C slave

I2C control is provided via pins 9 and 12 on J5.

This is the secondary XVF3000 I2C bus, on which the XVF3000 is a slave (see §6).

Pull-up resistors should be put on I2C_SDA_EXT and I2C_SCL_EXT.

The XVF3000 device and BaseBoard hardware *can* support other modes of audio connectivity and control. These modes are documented here for reference only - their use requires a different XVF3000 software.

- ▶ XVF3000 as I2S slave.

Audio input and output connectivity is provided via I2S, via pins 1, 3, 6 of J6 and pin 4 of J5.

I2S_DAC_DATA is the audio output from the host for the DAC far-end signal.

I2S_ADC_DATA is the audio input to the host from the XVF3000.

A 24.576 MHz MasterClock should be generated externally and connected to the BaseBoard via pin 15 of J5. To use this mode, remove R67 and insert a 0R link into R17.

- ▶ XVF3000 as USB audio and control device.

Input audio from the XVF3000 and output audio to the DAC is communicated over USB, and the XVF3000 device is controlled over USB.

In this mode, extension headers should be left unconnected.

Header pin J5	xCORE GPIO	Port	Signal
1	X0D22	P1G0	
2			GND
3	X0D23	P1H0	
4	X1D35	P1L0	I2S_ADC_DATA
5	X0D00	P1A0	
6			GND
7	X0D11	P1D0	
8			GND
9	X0D24	P1I0	I2C_SDA_EXT
10	X0D39	P1P0	
11			GND
12	X0D25	P1J0	I2C_SCL_EXT
13			3V3
14			GND
15			EXT_MCLK
16			GND

Figure 12:
Extension
header GPIO
J5

Header pin J6	xCORE GPIO	Port	Signal
1	X1D37	P1N0	I2S_LRCK
2	GND		
3	X1D39	P1P0	I2S_DAC_DATA
4	NC		
5	GND		
6	X1D36	P1M0	I2S_BCLK
7	X1D38	P1O0	MCLK_TILE1
8	GND		
9	X1D11	P1D0	
10	X1D10	P1C0	

Figure 13:
Extension
header GPIO
J6

9 USB port

The USB micro-B port (J1) provides power for all the on-board circuits and is used to generate the following voltage rails:

- ▶ +1V0 (Core voltage to XMOS device)
- ▶ +2V5 (for headphone amplifier in DAC device)
- ▶ +3V3 for GPIOs and other accessory devices

Voltage tolerance should be as per USB VBUS specification values.

Proper power-on sequence is indicated by power good LED (D1) in bottom side of the board.

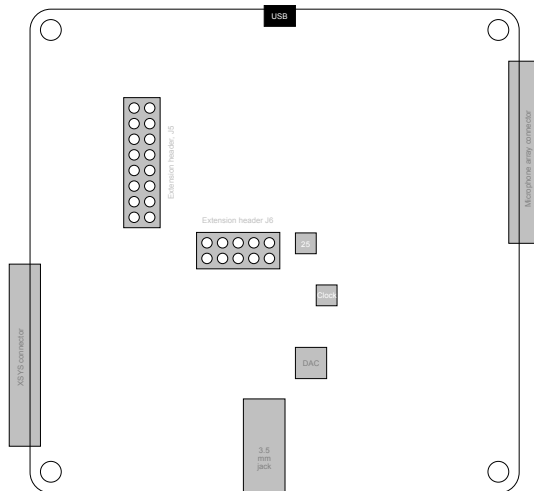

Figure 14:
USB
components

The data lines from the USB micro-B port (J1) are connected to the XVF3000's integrated USB PHY, and so (with a different XVF3000 software) *can* be used to provide USB audio and/or control connectivity to the XVF3000 and the BaseBoard.

Note:

- ▶ the software pre-flashed in to the **xCORE VocalFusion 4-Mic Kit for Amazon AVS** does **not** provide any USB connectivity.
- ▶ J1 must be connected at all times to provide power to the BaseBoard, even though the USB interface is not used.

10 Flash memory

The XVF3000 device includes 2MBytes of QSPI flash memory, which is interfaced by the GPIO connections shown in Figure 15:

QSPI connection	Pin	Port
QSPI_SS	X0D01	P1B
QSP_D0	X0D04	P4B0
QSP_D1	X0D05	P4B1
QSP_D2	X0D06	P4B2
QSP_D3	X0D07	P4B3
SPI_CLK	X0D10	P1C

Figure 15:
QSPI Flash

11 xSYS connector

A standard XMOS xSYS interface (J2) is provided to allow host debug of the board via JTAG.

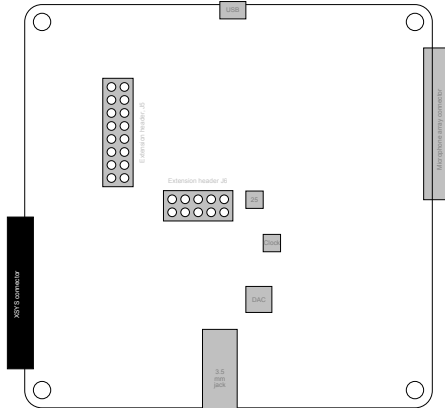

Figure 16:
xSYS
connector

xSYS signal	xCORE GPIO	Header pin	Description
TMS	See note	7	JTAG Test Mode Select
TCK	See note	9	JTAG Test Clock
TDI	See note	5	JTAG Test Data In - from debug adapter to xCORE
TDO	See note	13	JTAG Test Data Out - from xCORE to debug adapter
RST_N	See note	15	System Reset - active low, resets xCORE device
GND		4, 8, 12, 16, 20	Ground
XL_UP1	X0D43	6	XMOS link, uplink bit 1
XL_UP0	X0D42	10	XMOS link, uplink bit 0
XL_DN0	X0D40	14	XMOS link, downlink bit 0
XL_DN1	X0D41	18	XMOS link, downlink bit 1

Figure 17:
xSYS
Connector
Pinout

Notes:

- ▶ JTAG connections occupy dedicated connections

12 xCORE VocalFusion BaseBoard portmap

The table below provides a full description of the port-pin mappings described throughout this document for the xCORE VocalFusion BaseBoard.

Pin	1-bit	4-bit	8-bit	16-bit	32-bit	Signal
X0D00	1A ⁰					
X0D01	1B ⁰					QSPI_CS
X0D02		4A ⁰	8A ⁰	16A ⁰	32A ²⁰	BUTTON_A
X0D03		4A ¹	8A ¹	16A ¹	32A ²¹	BUTTON_B
X0D04		4B ⁰	8A ²	16A ²	32A ²²	QSPI_D0
X0D05		4B ¹	8A ³	16A ³	32A ²³	QSPI_D1
X0D06		4B ²	8A ⁴	16A ⁴	32A ²⁴	QSPI_D2
X0D07		4B ³	8A ⁵	16A ⁵	32A ²⁵	QSPI_D3
X0D08		4A ²	8A ⁶	16A ⁶	32A ²⁶	BUTTON_C
X0D09		4A ³	8A ⁷	16A ⁷	32A ²⁷	BUTTON_D
X0D10	1C ⁰					QSPI_CLK
X0D11	1D ⁰					
X0D12	1E ⁰					MIC_CLK
X0D13	1F ⁰					MCLK_IN
X0D14		4C ⁰	8B ⁰	16A ⁸	32A ²⁸	MIC_0
X0D15		4C ¹	8B ¹	16A ⁹	32A ²⁹	MIC_1
X0D16		4D ⁰	8B ²	16A ¹⁰		MIC_2
X0D17		4D ¹	8B ³	16A ¹¹		MIC_3
X0D18		4D ²	8B ⁴	16A ¹²		MIC_4
X0D19		4D ³	8B ⁵	16A ¹³		MIC_5
X0D20		4C ²	8B ⁶	16A ¹⁴	32A ³⁰	MIC_6
X0D21		4C ³	8B ⁷	16A ¹⁵	32A ³¹	MIC_7
X0D22	1G ⁰					
X0D23	1H ⁰					
X0D24	1I ⁰					
X0D25	1J ⁰					
X0D26		4E ⁰	8C ⁰	16B ⁰		LED_0
X0D27		4E ¹	8C ¹	16B ¹		LED_1
X0D28		4F ⁰	8C ²	16B ²		LED_2
X0D29		4F ¹	8C ³	16B ³		LED_3
X0D30		4F ²	8C ⁴	16B ⁴		LED_4
X0D31		4F ³	8C ⁵	16B ⁵		LED_5
X0D32		4E ²	8C ⁶	16B ⁶		LED_6
X0D33		4E ³	8C ⁷	16B ⁷		LED_7
X0D34	1K ⁰					LED_8
X0D35	1L ⁰					LED_9
X0D36	1M ⁰		8D ⁰	16B ⁸		LED_10
X0D37	1N ⁰		8D ¹	16B ⁹		LED_11
X0D38	1O ⁰		8D ²	16B ¹⁰		LED_12
X0D39	1P ⁰		8D ³	16B ¹¹		
X0D40			8D ⁴	16B ¹²		XL_DN1
X0D41			8D ⁵	16B ¹³		XL_DN0
X0D42			8D ⁶	16B ¹⁴		XL_UP0
X0D43			8D ⁷	16B ¹⁵		XL_UP1

Figure 18:
xCORE
VocalFusion
Base Board-
Portmap: Tile
0

Pin	1-bit	4-bit	8-bit	16-bit	32-bit	Signal
X1D00	1A ⁰					
X1D01	1B ⁰					
X1D02		4A ⁰	8A ⁰	16A ⁰	32A ²⁰	
X1D03		4A ¹	8A ¹	16A ¹	32A ²¹	
X1D04		4B ⁰	8A ²	16A ²	32A ²²	
X1D05		4B ¹	8A ³	16A ³	32A ²³	
X1D06		4B ²	8A ⁴	16A ⁴	32A ²⁴	
X1D07		4B ³	8A ⁵	16A ⁵	32A ²⁵	
X1D08		4A ²	8A ⁶	16A ⁶	32A ²⁶	
X1D09		4A ³	8A ⁷	16A ⁷	32A ²⁷	
X1D10	1C ⁰					
X1D11	1D ⁰					
X1D14		4C ⁰	8B ⁰	16A ⁸	32A ²⁸	
X1D15		4C ¹	8B ¹	16A ⁹	32A ²⁹	
X1D16		4D ⁰	8B ²	16A ¹⁰		
X1D17		4D ¹	8B ³	16A ¹¹		
X1D18		4D ²	8B ⁴	16A ¹²		
X1D19		4D ³	8B ⁵	16A ¹³		
X1D20		4C ²	8B ⁶	16A ¹⁴	32A ³⁰	
X1D21		4C ³	8B ⁷	16A ¹⁵	32A ³¹	
X1D26		4E ⁰	8C ⁰	16B ⁰		I2C_SCL
X1D27		4E ¹	8C ¹	16B ¹		I2C_SDA
X1D28		4F ⁰	8C ²	16B ²		DAC_RST_N
X1D29		4F ¹	8C ³	16B ³		
X1D30		4F ²	8C ⁴	16B ⁴		
X1D31		4F ³	8C ⁵	16B ⁵		
X1D32		4E ²	8C ⁶	16B ⁶		
X1D33		4E ³	8C ⁷	16B ⁷		
X1D35	1L ⁰					
X1D36	1M ⁰		8D ⁰	16B ⁸		I2S_BCLK
X1D37	1N ⁰		8D ¹	16B ⁹		I2S_LRCK
X1D38	1O ⁰		8D ²	16B ¹⁰		MCLK_TILE1
X1D39	1P ⁰		8D ³	16B ¹¹		I2S_DAC_DATA
X1D40			8D ⁴	16B ¹²		
X1D41			8D ⁵	16B ¹³		
X1D42			8D ⁶	16B ¹⁴		
X1D43			8D ⁷	16B ¹⁵		

Figure 19:
 xCORE
 VocalFusion
 BaseBoard
 Portmap: Tile
 1

13 Operating requirements

A USB 2.0 high-speed compliant cable of less than 3m in length should be used when operating the **xCORE VocalFusion 4-Mic Kit for Amazon AVS**. XMOS cannot guarantee correct operation of the base board should any other cable be used.

This product is, like most electronic equipment, sensitive to Electrostatic Discharge (ESD) events. Users should operate the **xCORE VocalFusion 4-Mic Kit for Amazon AVS** with appropriate ESD precautions in place.

14 Dimensions

The BaseBoard is 90x90mm square with a board thickness of 1.6mm.

15 RoHS and REACH

The **xCORE VocalFusion 4-Mic Kit for Amazon AVS** complies with appropriate RoHS2 and REACH regulations and is a Pb-free product.

The **xCORE VocalFusion 4-Mic Kit for Amazon AVS** is subject to the European Union WEEE directive and should not be disposed of in household waste. Alternative requirements may apply outside of the EU.



16 Schematics

The schematics for the Base Board included in the kit, are shown in the first five figures below, followed by the schematics for the linear array board.

For full reference schematics please contact XMOS:

► <https://www.xmos.com/contact/enquiries>

Figure 20:
xCORE
VocalFusion
BaseBoard -
XVF3000
configuration

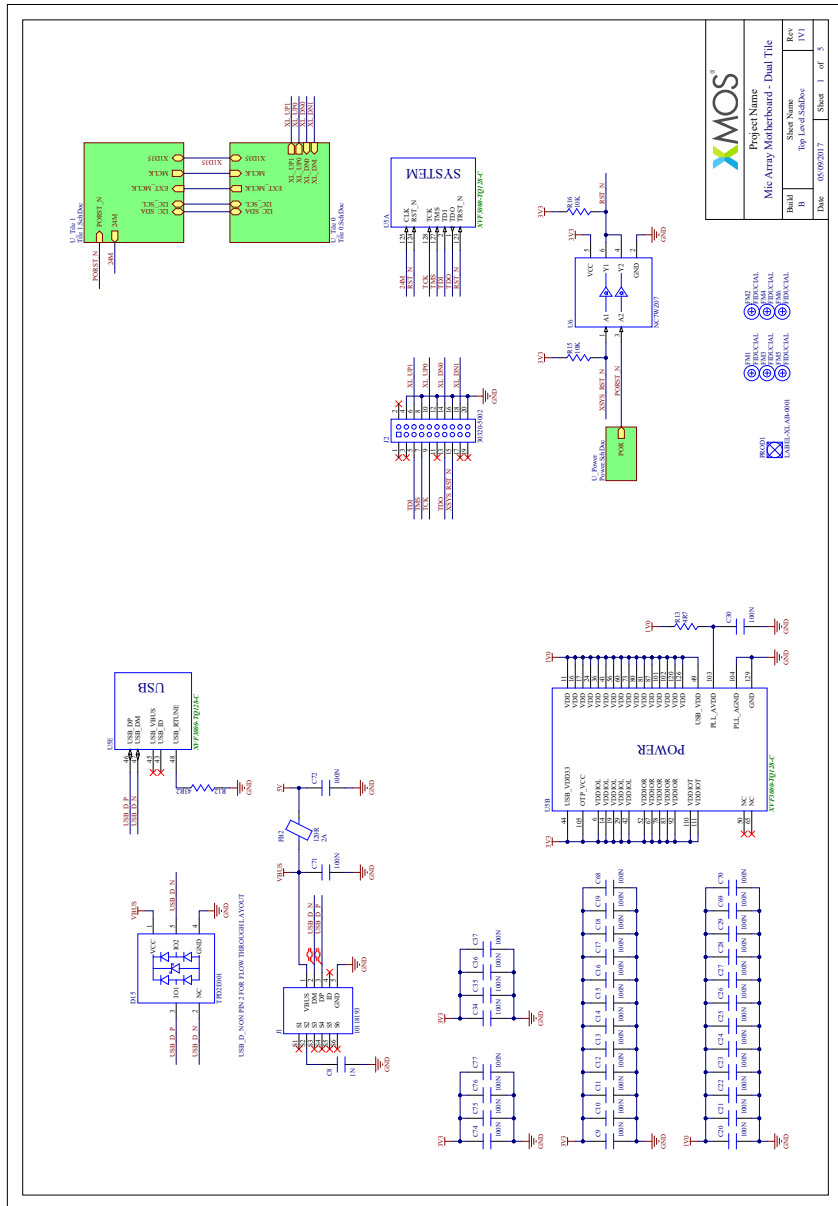
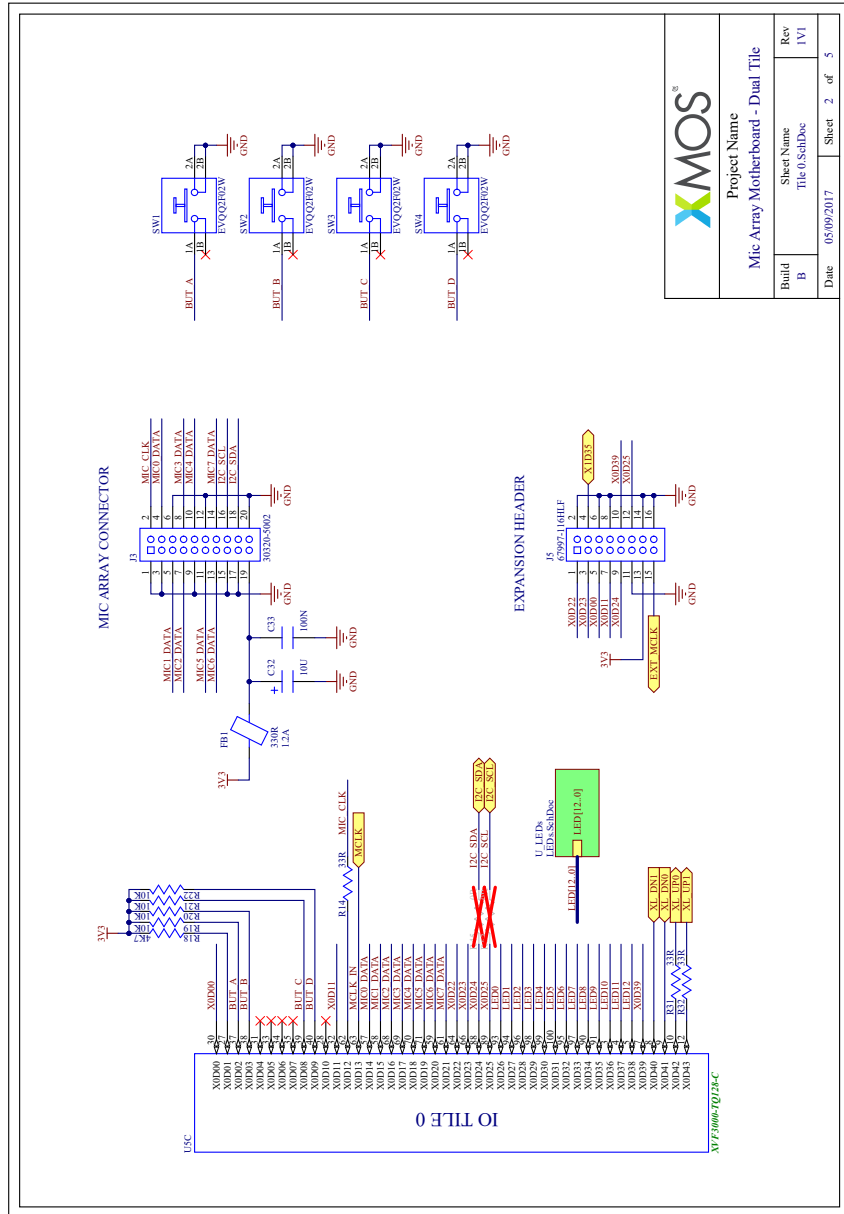

Figure 21:
xCORE
VocalFusion
BaseBoard -
extension
header,
buttons,
Microphone
header, Tile 0
IO



		Project Name	
		Mic Array Motherboard - Dual Tile	
Build	Sheet Name	Rev	
	B	Tile 0_SchDoc	1V1
Date	05/09/2017	Sheet	2 of 5

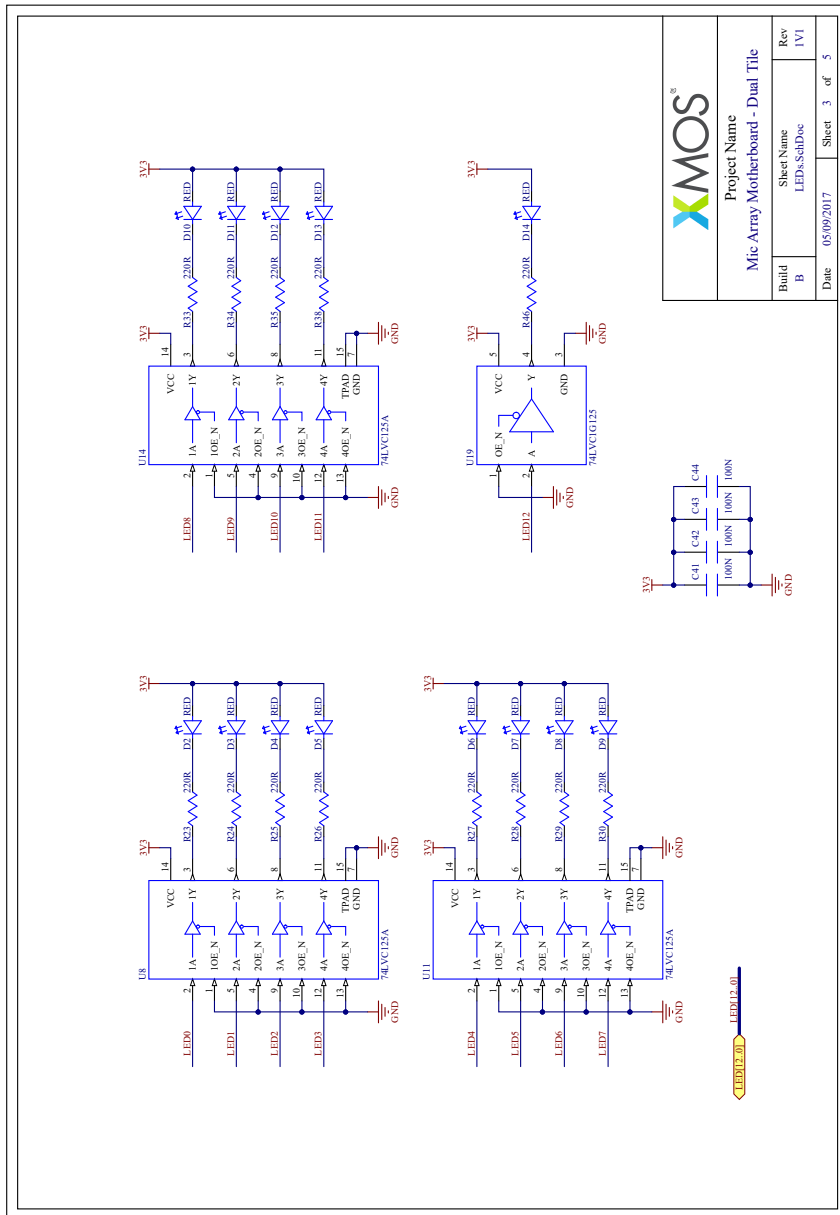

Figure 22:
xCORE
VocalFusion
BaseBoard -
LEDs

Figure 23:
xCORE
VocalFusion
BaseBoard -
Clock and
stereo DAC
with
headphone
jack circuitry,
tile 1 IO

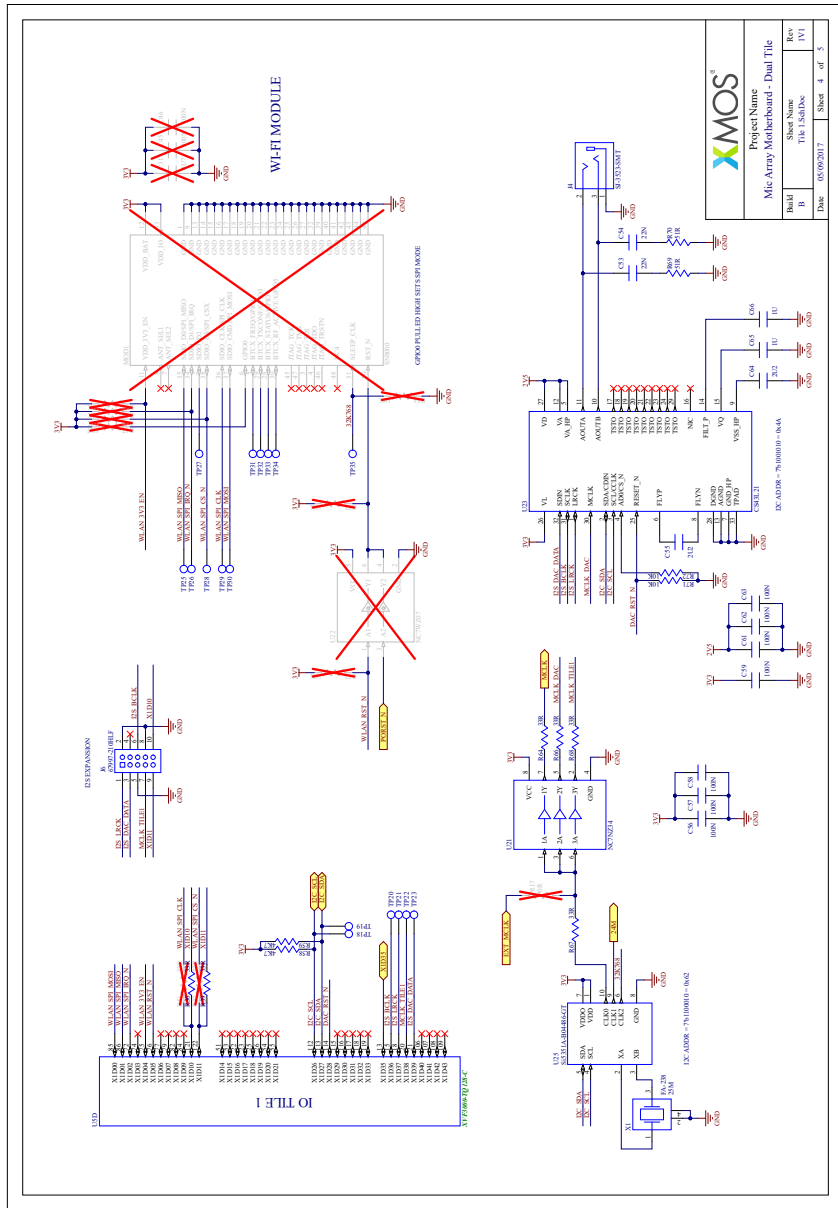
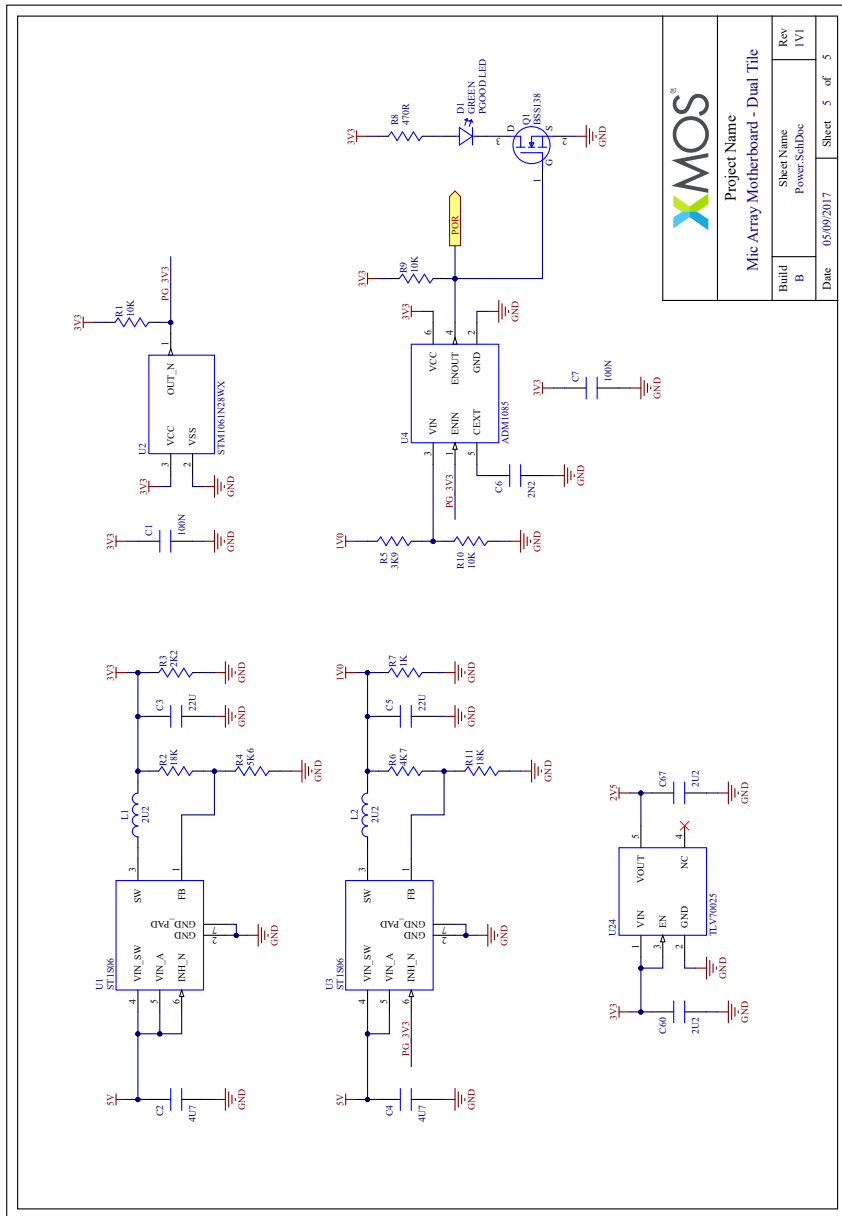

Figure 24:
 xCORE
 VocalFusion
 BaseBoard -
 voltage rail
 LDOs and
 reset circuit



		Project Name	
		Mic Array Motherboard - Dual Tile	
Build	Sheet Name		Rev
	Power-SahDae		1V1
Date	05/09/2017	Sheet	5 of 5

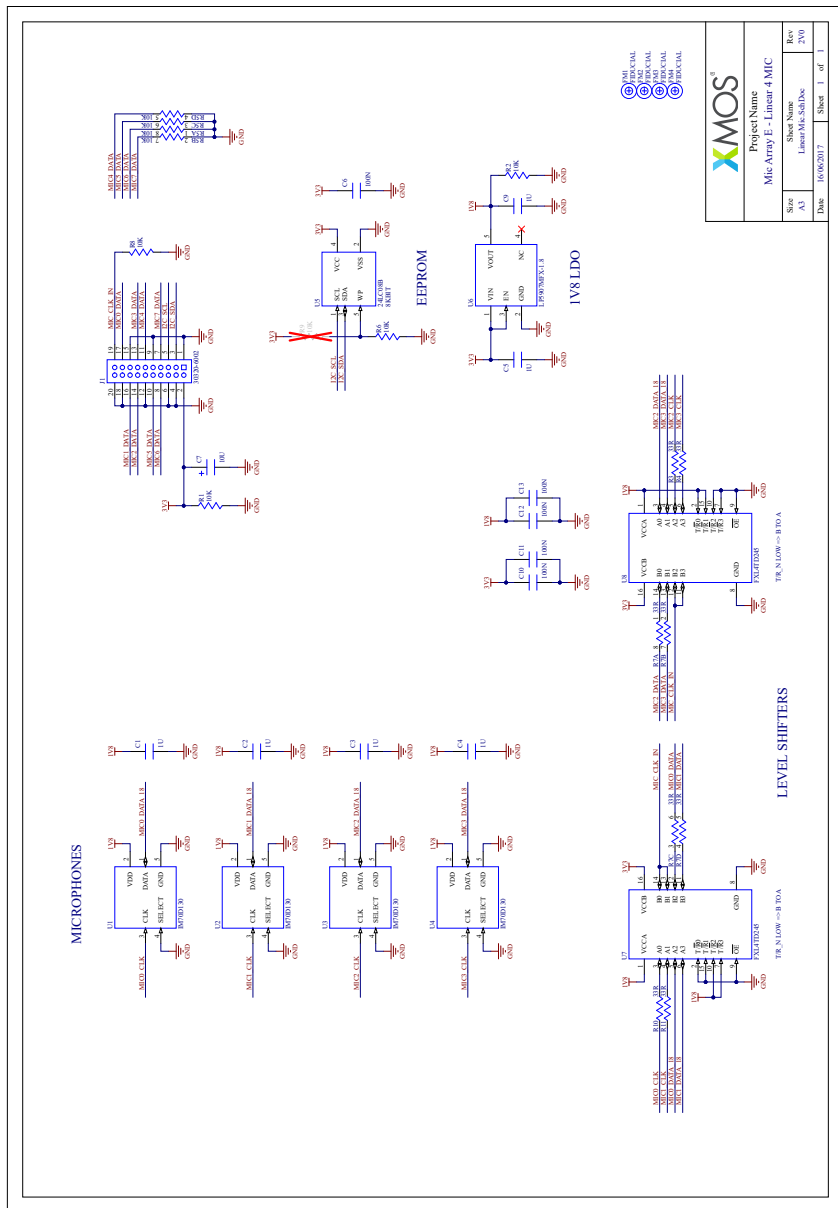

Figure 25:
xCORE
VocalFusion -
Linear
Microphone
Board



Copyright © 2017, All Rights Reserved.

Xmos Ltd. is the owner or licensee of this design, code, or Information (collectively, the "Information") and is providing it to you "AS IS" with no warranty of any kind, express or implied and shall have no liability in relation to its use. Xmos Ltd. makes no representation that the Information, or any particular implementation thereof, is or will be free from any claims of infringement and again, shall have no liability in relation to any such claims.