

PRELIMINARY

XL208-128-TQ128 Datasheet

2015/08/27

XMOS © 2015, All Rights Reserved

Document Number: X010113,



PRELIMINARY

Table of Contents

| | | |
|----|--------------------------------------|----|
| 1 | xCORE Multicore Microcontrollers | 2 |
| 2 | XL208-128-TQ128 Features | 4 |
| 3 | Pin Configuration | 5 |
| 4 | Signal Description | 6 |
| 5 | Example Application Diagram | 9 |
| 6 | Product Overview | 10 |
| 7 | PLL | 13 |
| 8 | Boot Procedure | 14 |
| 9 | Memory | 18 |
| 10 | JTAG | 18 |
| 11 | Board Integration | 19 |
| 12 | DC and Switching Characteristics | 23 |
| 13 | Package Information | 26 |
| 14 | Ordering Information | 27 |
| | Appendices | 28 |
| A | Configuration of the XL208-128-TQ128 | 28 |
| B | Processor Status Configuration | 30 |
| C | Tile Configuration | 41 |
| D | Node Configuration | 49 |
| E | Device Errata | 57 |
| F | JTAG, xSCOPE and Debugging | 57 |
| G | Schematics Design Check List | 59 |
| H | PCB Layout Design Check List | 61 |
| I | Associated Design Documentation | 62 |
| J | Related Documentation | 62 |
| K | Revision History | 63 |

TO OUR VALUED CUSTOMERS

It is our intention to provide you with accurate and comprehensive documentation for the hardware and software components used in this product. To subscribe to receive updates, visit <http://www.xmos.com/>.

XMOS Ltd. is the owner or licensee of the information in this document and is providing it to you "AS IS" with no warranty of any kind, express or implied and shall have no liability in relation to its use. XMOS Ltd. makes no representation that the information, or any particular implementation thereof, is or will be free from any claims of infringement and again, shall have no liability in relation to any such claims.

XMOS and the XMOS logo are registered trademarks of XMOS Ltd in the United Kingdom and other countries, and may not be used without written permission. Company and product names mentioned in this document are the trademarks or registered trademarks of their respective owners.

PRELIMINARY

1 xCORE Multicore Microcontrollers

The xCORE-200 Series is a comprehensive range of 32-bit multicore microcontrollers that brings the low latency and timing determinism of the xCORE architecture to mainstream embedded applications. Unlike conventional microcontrollers, xCORE multicore microcontrollers execute multiple real-time tasks simultaneously and communicate between tasks using a high speed network. Because xCORE multicore microcontrollers are completely deterministic, you can write software to implement functions that traditionally require dedicated hardware.

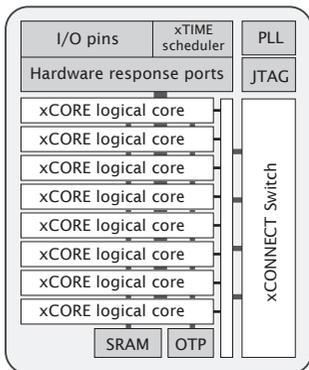

Figure 1:
XL208-128-
TQ128 block
diagram

Key features of the XL208-128-TQ128 include:

- ▶ **Tiles:** Devices consist of one or more xCORE tiles. Each tile contains between five and eight 32-bit xCOREs with highly integrated I/O and on-chip memory.
- ▶ **Logical cores** Each logical core can execute tasks such as computational code, DSP code, control software (including logic decisions and executing a state machine) or software that handles I/O. Section [6.1](#)
- ▶ **xTIME scheduler** The xTIME scheduler performs functions similar to an RTOS, in hardware. It services and synchronizes events in a core, so there is no requirement for interrupt handler routines. The xTIME scheduler triggers cores on events generated by hardware resources such as the I/O pins, communication channels and timers. Once triggered, a core runs independently and concurrently to other cores, until it pauses to wait for more events. Section [6.2](#)
- ▶ **Channels and channel ends** Tasks running on logical cores communicate using channels formed between two channel ends. Data can be passed synchronously or asynchronously between the channel ends assigned to the communicating tasks. Section [6.5](#)
- ▶ **xCONNECT Switch and Links** Between tiles, channel communications are implemented over a high performance network of xCONNECT Links and routed through a hardware xCONNECT Switch. Section [6.6](#)

PRELIMINARY

- ▶ **Ports** The I/O pins are connected to the processing cores by Hardware Response ports. The port logic can drive its pins high and low, or it can sample the value on its pins optionally waiting for a particular condition. Section 6.3
- ▶ **Clock blocks** xCORE devices include a set of programmable clock blocks that can be used to govern the rate at which ports execute. Section 6.4
- ▶ **Memory** Each xCORE Tile integrates a bank of SRAM for instructions and data, and a block of one-time programmable (OTP) memory that can be configured for system wide security features. Section 9
- ▶ **PLL** The PLL is used to create a high-speed processor clock given a low speed external oscillator. Section 7
- ▶ **JTAG** The JTAG module can be used for loading programs, boundary scan testing, in-circuit source-level debugging and programming the OTP memory. Section 10

1.1 Software

Devices are programmed using C, C++ or xC (C with multicore extensions). XMOS provides tested and proven software libraries, which allow you to quickly add interface and processor functionality such as USB, Ethernet, PWM, graphics driver, and audio EQ to your applications.

1.2 xTIMEcomposer Studio

The xTIMEcomposer Studio development environment provides all the tools you need to write and debug your programs, profile your application, and write images into flash memory or OTP memory on the device. Because xCORE devices operate deterministically, they can be simulated like hardware within xTIMEcomposer: uniquely in the embedded world, xTIMEcomposer Studio therefore includes a static timing analyzer, cycle-accurate simulator, and high-speed in-circuit instrumentation.

xTIMEcomposer can be driven from either a graphical development environment, or the command line. The tools are supported on Windows, Linux and MacOS X and available at no cost from xmos.com/downloads. Information on using the tools is provided in the xTIMEcomposer User Guide, [X3766](#).

2 XL208-128-TQ128 Features

► **Multicore Microcontroller with Advanced Multi-Core RISC Architecture**

- Eight real-time logical cores
- Core share up to 500 MIPS
 - Up to 1000 MIPS in dual issue mode
- Each logical core has:
 - Guaranteed throughput of between $1/5$ and $1/8$ of tile MIPS
 - 16x32bit dedicated registers
- 167 high-density 16/32-bit instructions
 - All have single clock-cycle execution (except for divide)
 - 32x32→64-bit MAC instructions for DSP, arithmetic and user-definable cryptographic functions

► **Programmable I/O**

- 33 general-purpose I/O pins, configurable as input or output
 - Up to 32 x 1bit port, 12 x 4bit port, 8 x 8bit port, 4 x 16bit port
 - 4 xCONNECT links
- Port sampling rates of up to 60 MHz with respect to an external clock
- 32 channel ends for communication with other cores, on or off-chip

► **Memory**

- 128KB internal single-cycle SRAM for code and data storage
- 8KB internal OTP for application boot code

► **Hardware resources**

- 6 clock blocks
- 10 timers
- 4 locks

► **JTAG Module for On-Chip Debug**

► **Security Features**

- Programming lock disables debug and prevents read-back of memory contents
- AES bootloader ensures secrecy of IP held on external flash memory

► **Ambient Temperature Range**

- -40°C to 105°C

► **Speed Grade**

- 10: 500 MIPS

► **Power Consumption**

- TBC mA (typical)

► **128-pin TQFP package 0.4 mm pitch**

PRELIMINARY

3 Pin Configuration

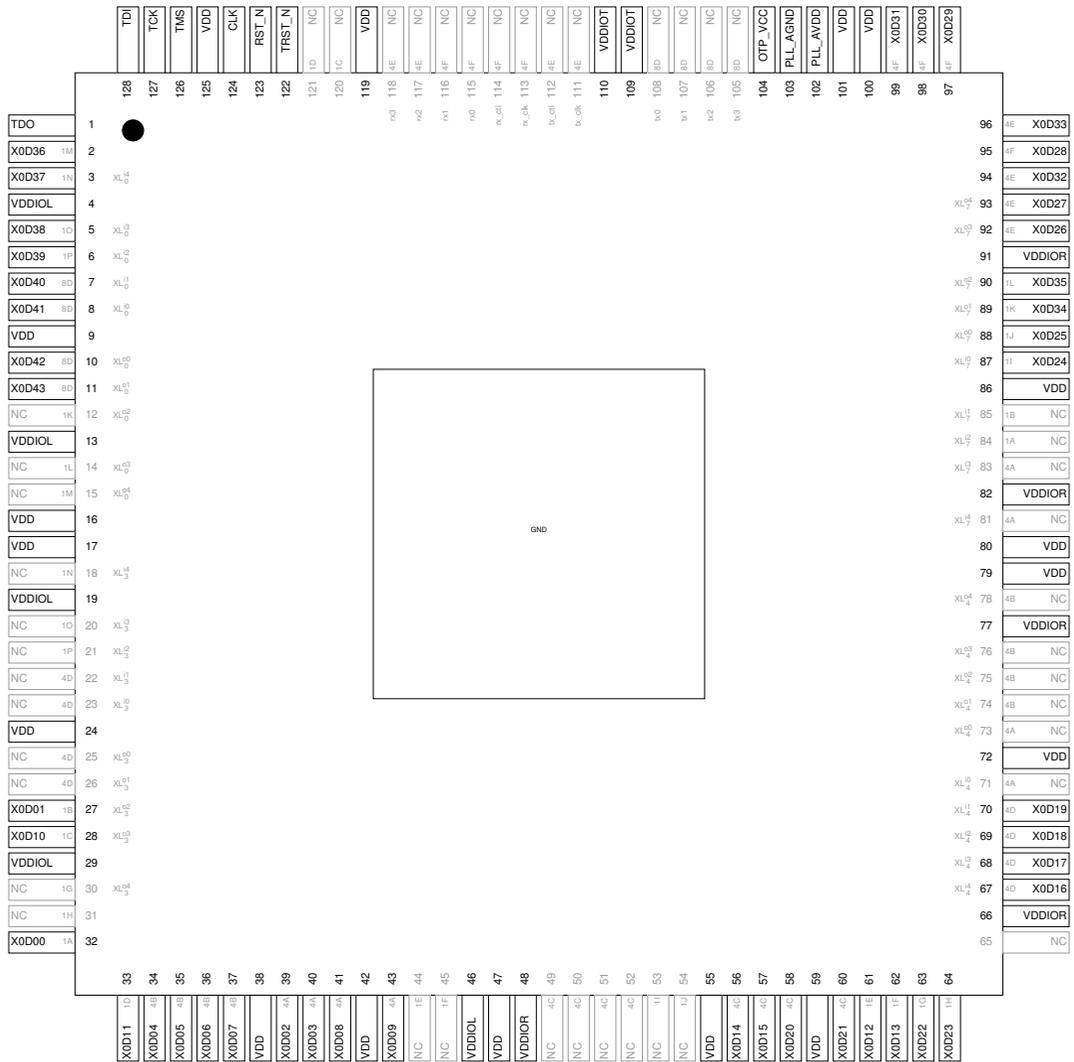

4 Signal Description

This section lists the signals and I/O pins available on the XL208-128-TQ128. The device provides a combination of 1bit, 4bit, 8bit and 16bit ports, as well as wider ports that are fully or partially (gray) bonded out. All pins of a port provide either output or input, but signals in different directions cannot be mapped onto the same port.

Pins may have one or more of the following properties:

- ▶ PD/PU: The IO pin a weak pull-down or pull-up resistor. On GPIO pins this resistor can be enabled.
- ▶ ST: The IO pin has a Schmitt Trigger on its input.
- ▶ IOL/IOT/IOR: The IO pin is powered from VDDIOL, VDDIOT, and VDDIOR respectively

| Power pins (8) | | | |
|----------------|---------------------------|------|------------|
| Signal | Function | Type | Properties |
| GND | Digital ground | GND | |
| OTP_VCC | OTP power supply | PWR | |
| PLL_AGND | Analog ground for PLL | PWR | |
| PLL_AVDD | Analog PLL power | PWR | |
| VDD | Digital tile power | PWR | |
| VDDIOL | Digital I/O power (left) | PWR | |
| VDDIOR | Digital I/O power (right) | PWR | |
| VDDIOT | Digital I/O power (top) | PWR | |

| JTAG pins (6) | | | |
|---------------|--------------------|--------|-------------|
| Signal | Function | Type | Properties |
| RST_N | Global reset input | Input | IOL, PU, ST |
| TCK | Test clock | Input | IOL, PD, ST |
| TDI | Test data input | Input | IOL, PU |
| TDO | Test data output | Output | IOL, PD |
| TMS | Test mode select | Input | IOL, PU |
| TRST_N | Test reset input | Input | IOL, PU, ST |

| I/O pins (44) | | | |
|---------------|--|------|------------|
| Signal | Function | Type | Properties |
| X0D00 | 1A ⁰ | I/O | IOL, PD |
| X0D01 | XL3 _{out} ² 1B ⁰ | I/O | IOL, PD |
| X0D02 | 4A ⁰ 8A ⁰ 16A ⁰ 32A ²⁰ | I/O | IOL, PD |
| X0D03 | 4A ¹ 8A ¹ 16A ¹ 32A ²¹ | I/O | IOL, PD |

(continued)

PRELIMINARY

| Signal | Function | Type | Properties |
|--------|---------------------------------------|------|------------|
| X0D04 | $4B^0 \ 8A^2 \ 16A^2 \ 32A^{22}$ | I/O | IOL, PD |
| X0D05 | $4B^1 \ 8A^3 \ 16A^3 \ 32A^{23}$ | I/O | IOL, PD |
| X0D06 | $4B^2 \ 8A^4 \ 16A^4 \ 32A^{24}$ | I/O | IOL, PD |
| X0D07 | $4B^3 \ 8A^5 \ 16A^5 \ 32A^{25}$ | I/O | IOL, PD |
| X0D08 | $4A^2 \ 8A^6 \ 16A^6 \ 32A^{26}$ | I/O | IOL, PD |
| X0D09 | $4A^3 \ 8A^7 \ 16A^7 \ 32A^{27}$ | I/O | IOL, PD |
| X0D10 | $XL3_{out}^3 \ 1C^0$ | I/O | IOL, PD |
| X0D11 | $1D^0$ | I/O | IOL, PD |
| X0D12 | $1E^0$ | I/O | IOR, PD |
| X0D13 | $1F^0$ | I/O | IOR, PD |
| X0D14 | $4C^0 \ 8B^0 \ 16A^8 \ 32A^{28}$ | I/O | IOR, PD |
| X0D15 | $4C^1 \ 8B^1 \ 16A^9 \ 32A^{29}$ | I/O | IOR, PD |
| X0D16 | $XL4_{in}^4 \ 4D^0 \ 8B^2 \ 16A^{10}$ | I/O | IOR, PD |
| X0D17 | $XL4_{in}^3 \ 4D^1 \ 8B^3 \ 16A^{11}$ | I/O | IOR, PD |
| X0D18 | $XL4_{in}^2 \ 4D^2 \ 8B^4 \ 16A^{12}$ | I/O | IOR, PD |
| X0D19 | $XL4_{in}^1 \ 4D^3 \ 8B^5 \ 16A^{13}$ | I/O | IOR, PD |
| X0D20 | $4C^2 \ 8B^6 \ 16A^{14} \ 32A^{30}$ | I/O | IOR, PD |
| X0D21 | $4C^3 \ 8B^7 \ 16A^{15} \ 32A^{31}$ | I/O | IOR, PD |
| X0D22 | $1G^0$ | I/O | IOR, PD |
| X0D23 | $1H^0$ | I/O | IOR, PD |
| X0D24 | $XL7_{in}^0 \ 1I^0$ | I/O | IOR, PD |
| X0D25 | $XL7_{out}^0 \ 1J^0$ | I/O | IOR, PD |
| X0D26 | $XL7_{out}^3 \ 4E^0 \ 8C^0 \ 16B^0$ | I/O | IOR, PD |
| X0D27 | $XL7_{out}^4 \ 4E^1 \ 8C^1 \ 16B^1$ | I/O | IOR, PD |
| X0D28 | $4F^0 \ 8C^2 \ 16B^2$ | I/O | IOR, PD |
| X0D29 | $4F^1 \ 8C^3 \ 16B^3$ | I/O | IOR, PD |
| X0D30 | $4F^2 \ 8C^4 \ 16B^4$ | I/O | IOR, PD |
| X0D31 | $4F^3 \ 8C^5 \ 16B^5$ | I/O | IOR, PD |
| X0D32 | $4E^2 \ 8C^6 \ 16B^6$ | I/O | IOR, PD |
| X0D33 | $4E^3 \ 8C^7 \ 16B^7$ | I/O | IOR, PD |
| X0D34 | $XL7_{out}^1 \ 1K^0$ | I/O | IOR, PD |
| X0D35 | $XL7_{out}^2 \ 1L^0$ | I/O | IOR, PD |
| X0D36 | $1M^0 \ 8D^0 \ 16B^8$ | I/O | IOL, PD |
| X0D37 | $XL0_{in}^4 \ 1N^0 \ 8D^1 \ 16B^9$ | I/O | IOL, PD |
| X0D38 | $XL0_{in}^3 \ 1O^0 \ 8D^2 \ 16B^{10}$ | I/O | IOL, PD |
| X0D39 | $XL0_{in}^2 \ 1P^0 \ 8D^3 \ 16B^{11}$ | I/O | IOL, PD |
| X0D40 | $XL0_{in}^1 \ 8D^4 \ 16B^{12}$ | I/O | IOL, PD |
| X0D41 | $XL0_{in}^0 \ 8D^5 \ 16B^{13}$ | I/O | IOL, PD |
| X0D42 | $XL0_{out}^0 \ 8D^6 \ 16B^{14}$ | I/O | IOL, PD |
| X0D43 | $XL0_{out}^1 \ 8D^7 \ 16B^{15}$ | I/O | IOL, PD |

PRELIMINARY

| System pins (1) | | | |
|-----------------|---------------------|-------|-------------|
| Signal | Function | Type | Properties |
| CLK | PLL reference clock | Input | IOL, PD, ST |

PRELIMINARY

5 Example Application Diagram

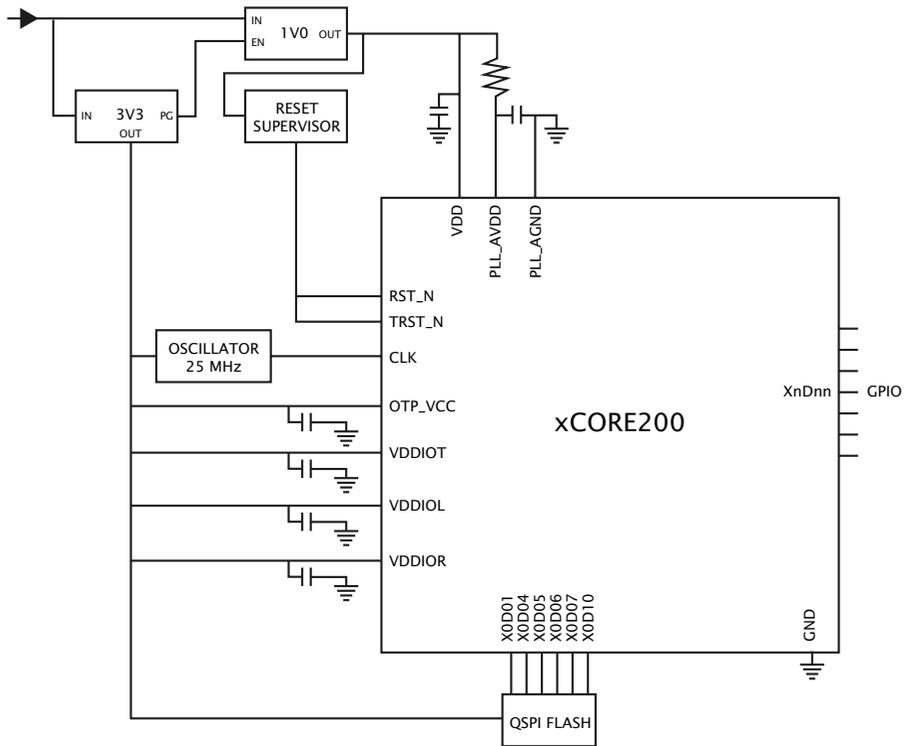

Figure 2:
Simplified
Reference
Schematic

6 Product Overview

The XL208-128-TQ128 is a powerful device that consists of a single xCORE Tile, which comprises a flexible logical processing cores with tightly integrated I/O and on-chip memory.

6.1 Logical cores

The tile has 8 active logical cores, which issue instructions down a shared five-stage pipeline. Instructions from the active cores are issued round-robin. If up to five logical cores are active, each core is allocated a fifth of the processing cycles. If more than five logical cores are active, each core is allocated at least $1/n$ cycles (for n cores). Figure 3 shows the guaranteed core performance depending on the number of cores used.

Figure 3:
Logical core performance

| Speed grade | MIPS | Frequency | Minimum MIPS per core (for n cores) | | | | | | | |
|-------------|----------|-----------|---------------------------------------|-----|-----|-----|-----|----|----|----|
| | | | 1 | 2 | 3 | 4 | 5 | 6 | 7 | 8 |
| 5 | 500 MIPS | 500 MHz | 100 | 100 | 100 | 100 | 100 | 83 | 71 | 63 |

There is no way that the performance of a logical core can be reduced below these predicted levels (unless *priority threads* are used: in this case the guaranteed minimum performance is computed based on the number of priority threads as defined in the architecture manual). Because cores may be delayed on I/O, however, their unused processing cycles can be taken by other cores. This means that for more than five logical cores, the performance of each core is often higher than the predicted minimum but cannot be guaranteed.

The logical cores are triggered by events instead of interrupts and run to completion. A logical core can be paused to wait for an event.

6.2 xTIME scheduler

The xTIME scheduler handles the events generated by xCORE Tile resources, such as channel ends, timers and I/O pins. It ensures that all events are serviced and synchronized, without the need for an RTOS. Events that occur at the I/O pins are handled by the Hardware-Response ports and fed directly to the appropriate xCORE Tile. An xCORE Tile can also choose to wait for a specified time to elapse, or for data to become available on a channel.

Tasks do not need to be prioritised as each of them runs on their own logical xCORE. It is possible to share a set of low priority tasks on a single core using cooperative multitasking.

6.3 Hardware Response Ports

Hardware Response ports connect an xCORE tile to one or more physical pins and as such define the interface between hardware attached to the XL208-128-TQ128, and the software running on it. A combination of 1bit, 4bit, 8bit, 16bit and 32bit

PRELIMINARY

ports are available. All pins of a port provide either output or input. Signals in different directions cannot be mapped onto the same port.

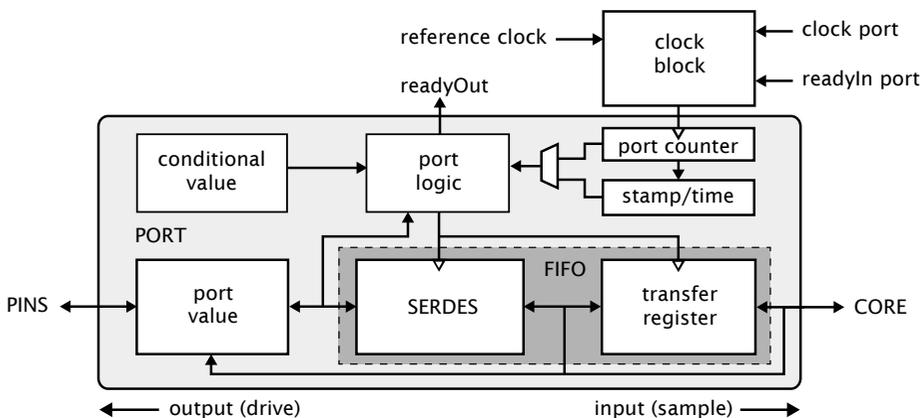

Figure 4:
Port block
diagram

The port logic can drive its pins high or low, or it can sample the value on its pins, optionally waiting for a particular condition. Ports are accessed using dedicated instructions that are executed in a single processor cycle. xCORE-200 IO pins can be used as *open collector* outputs, where signals are driven low if a zero is output, but left high impedance if a one is output. This option is set on a per-port basis.

Data is transferred between the pins and core using a FIFO that comprises a SERDES and transfer register, providing options for serialization and buffered data.

Each port has a 16-bit counter that can be used to control the time at which data is transferred between the port value and transfer register. The counter values can be obtained at any time to find out when data was obtained, or used to delay I/O until some time in the future. The port counter value is automatically saved as a timestamp, that can be used to provide precise control of response times.

The ports and xCONNECT links are multiplexed onto the physical pins. If an xConnect Link is enabled, the pins of the underlying ports are disabled. If a port is enabled, it overrides ports with higher widths that share the same pins. The pins on the wider port that are not shared remain available for use when the narrower port is enabled. Ports always operate at their specified width, even if they share pins with another port.

6.4 Clock blocks

xCORE devices include a set of programmable clocks called clock blocks that can be used to govern the rate at which ports execute. Each xCORE tile has six clock blocks: the first clock block provides the tile reference clock and runs at a default frequency of 100MHz; the remaining clock blocks can be set to run at different frequencies.

PRELIMINARY

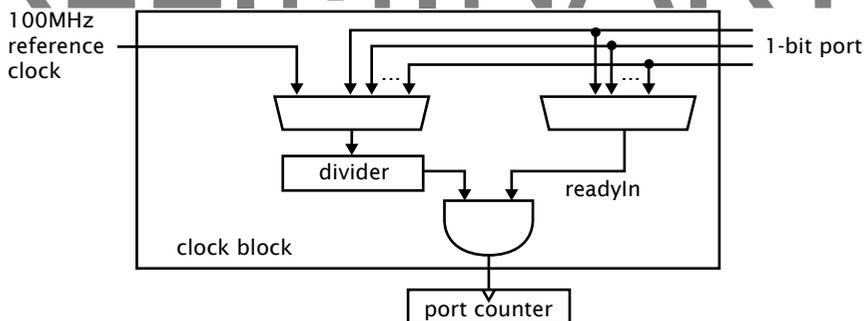

Figure 5:
Clock block
diagram

A clock block can use a 1-bit port as its clock source allowing external application clocks to be used to drive the input and output interfaces. xCORE-200 clock blocks optionally divide the clock input from a 1-bit port.

In many cases I/O signals are accompanied by strobing signals. The xCORE ports can input and interpret strobe (known as readyIn and readyOut) signals generated by external sources, and ports can generate strobe signals to accompany output data.

On reset, each port is connected to clock block 0, which runs from the xCORE Tile reference clock.

6.5 Channels and Channel Ends

Logical cores communicate using point-to-point connections, formed between two channel ends. A channel-end is a resource on an xCORE tile, that is allocated by the program. Each channel-end has a unique system-wide identifier that comprises a unique number and their tile identifier. Data is transmitted to a channel-end by an output-instruction; and the other side executes an input-instruction. Data can be passed synchronously or asynchronously between the channel ends.

6.6 xCONNECT Switch and Links

XMOS devices provide a scalable architecture, where multiple xCORE devices can be connected together to form one system. Each xCORE device has an xCONNECT interconnect that provides a communication infrastructure for all tasks that run on the various xCORE tiles on the system.

The interconnect relies on a collection of switches and XMOS links. Each xCORE device has an on-chip switch that can set up circuits or route data. The switches are connected by xConnect Links. An XMOS link provides a physical connection between two switches. The switch has a routing algorithm that supports many different topologies, including lines, meshes, trees, and hypercubes.

The links operate in either 2 wires per direction or 5 wires per direction mode, depending on the amount of bandwidth required. Circuit switched, streaming

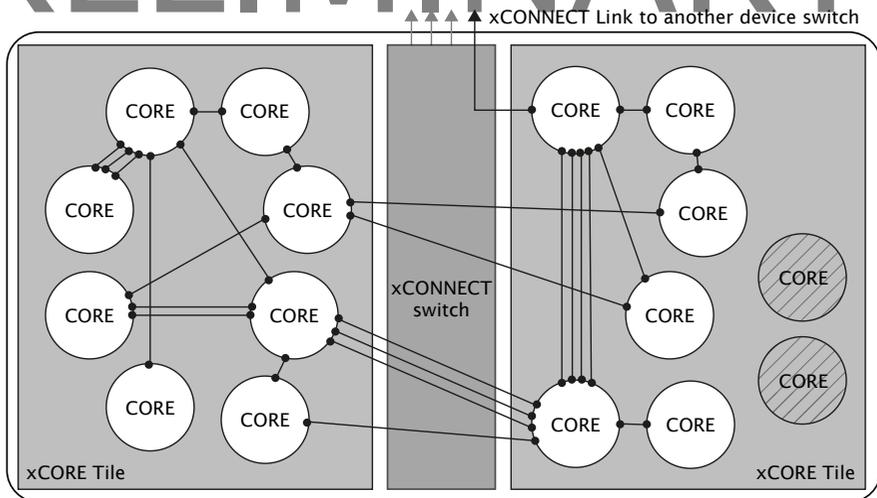

Figure 6:
Switch, links
and channel
ends

and packet switched data can both be supported efficiently. Streams provide the fastest possible data rates between xCORE Tiles (up to 250 MBit/s), but each stream requires a single link to be reserved between switches on two tiles. All packet communications can be multiplexed onto a single link.

Information on the supported routing topologies that can be used to connect multiple devices together can be found in the XS1-L Link Performance and Design Guide, [X2999](#).

7 PLL

The PLL creates a high-speed clock that is used for the switch, tile, and reference clock. The initial PLL multiplication value is shown in Figure 7:

Figure 7:
The initial PLL
multiplier
values

| Oscillator Frequency | Tile Frequency | PLL Ratio | PLL settings | | |
|----------------------|----------------|-----------|--------------|----|---|
| | | | OD | F | R |
| 9-25 MHz | 144-400 MHz | 16 | 1 | 63 | 0 |

Figure 7 also lists the values of *OD*, *F* and *R*, which are the registers that define the ratio of the tile frequency to the oscillator frequency:

$$F_{core} = F_{osc} \times \frac{F + 1}{2} \times \frac{1}{R + 1} \times \frac{1}{OD + 1}$$

OD, *F* and *R* must be chosen so that $0 \leq R \leq 63$, $0 \leq F \leq 4095$, $0 \leq OD \leq 7$, and $260MHz \leq F_{osc} \times \frac{F+1}{2} \times \frac{1}{R+1} \leq 1.3GHz$. The *OD*, *F*, and *R* values can be modified by writing to the digital node PLL configuration register.

PRELIMINARY

If a different tile frequency is required (eg, 500 MHz), then the PLL must be reprogrammed after boot to provide the required tile frequency. The XMOS tools perform this operation by default. Further details on configuring the clock can be found in the xCORE-200 Clock Frequency Control document.

8 Boot Procedure

The device is kept in reset by driving RST_N low. When in reset, all GPIO pins have a pull-down enabled. When the device is taken out of reset by releasing RST_N the processor starts its internal reset process. After 15-150 μs (depending on the input clock) the processor boots.

The xCORE Tile boot procedure is illustrated in Figure 8. If bit 5 of the security register (see §9.1) is set, the device boots from OTP. To get a high value, a 3K3 pull-up resistor should be strapped onto the pin. To assure a low value, a pull-down resistor is required if other external devices are connected to this port.

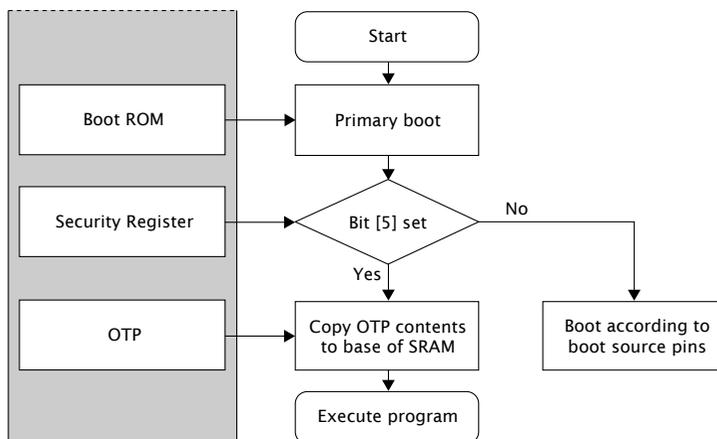

Figure 8:
Boot procedure

| X0D06 | X0D05 | X0D04 | Tile 0 boot | Enabled links |
|-------|-------|-------|---------------|-----------------------------|
| 0 | 0 | 0 | QSPI master | None |
| 0 | 0 | 1 | SPI master | None |
| 0 | 1 | 0 | SPI slave | None |
| 0 | 1 | 1 | SPI slave | None |
| 1 | 0 | 0 | Channel end 0 | XL0 (2w) |
| 1 | 0 | 1 | Channel end 0 | XL4-XL7 (5w) |
| 1 | 1 | 0 | Channel end 0 | XL1, XL2, XL5, and XL6 (5w) |
| 1 | 1 | 1 | Channel end 0 | XL0-XL3 (5w) |

Figure 9:
Boot source pins

The boot image has the following format:

- ▶ A 32-bit program size *s* in words.

PRELIMINARY

- ▶ Program consisting of $s \times 4$ bytes.
- ▶ A 32-bit CRC, or the value 0x0D15AB1E to indicate that no CRC check should be performed.

The program size and CRC are stored least significant byte first. The program is loaded into the lowest memory address of RAM, and the program is started from that address. The CRC is calculated over the byte stream represented by the program size and the program itself. The polynomial used is 0xEDB88320 (IEEE 802.3); the CRC register is initialized with 0xFFFFFFFF and the residue is inverted to produce the CRC.

8.1 Boot from QSPI master

If set to boot from QSPI master, the processor enables the six pins specified in Figure 10, and drives the SPI clock at 50 MHz (assuming a 400 MHz core clock). A READ command is issued with a 24-bit address 0x000000. The clock polarity and phase are 0 / 0.

Figure 10:
QSPI pins

| Pin | Signal | Description |
|--------------|--------|--------------|
| X0D01 | SS | Slave Select |
| X0D04..X0D07 | SPIO | Data |
| X0D10 | SCLK | Clock |

The xCORE Tile expects each byte to be transferred with the *least-significant nibble first*. Programmers who write bytes into an QSPI interface using the most significant nibble first may have to reverse the nibbles in each byte of the image stored in the QSPI device.

The pins used for QSPI boot are hardcoded in the boot ROM and cannot be changed. If required, an QSPI boot program can be burned into OTP that uses different pins.

8.2 Boot from SPI master

If set to boot from SPI master, the processor enables the four pins specified in Figure 11, and drives the SPI clock at 2.5 MHz (assuming a 400 MHz core clock). A READ command is issued with a 24-bit address 0x000000. The clock polarity and phase are 0 / 0.

Figure 11:
SPI master pins

| Pin | Signal | Description |
|-------|--------|----------------------------|
| X0D00 | MISO | Master In Slave Out (Data) |
| X0D01 | SS | Slave Select |
| X0D10 | SCLK | Clock |
| X0D11 | MOSI | Master Out Slave In (Data) |

The xCORE Tile expects each byte to be transferred with the *least-significant bit first*. Programmers who write bytes into an SPI interface using the most significant bit first may have to reverse the bits in each byte of the image stored in the SPI device.

PRELIMINARY

If a large boot image is to be read in, it is faster to first load a small boot-loader that reads the large image using a faster SPI clock, for example 50 MHz or as fast as the flash device supports.

The pins used for SPI boot are hardcoded in the boot ROM and cannot be changed. If required, an SPI boot program can be burned into OTP that uses different pins.

8.3 Boot from SPI slave

If set to boot from SPI slave, the processor enables the three pins specified in Figure 12 and expects a boot image to be clocked in. The supported clock polarity and phase are 0/0 and 1/1.

| Pin | Signal | Description |
|-------|--------|----------------------------|
| X0D00 | SS | Slave Select |
| X0D10 | SCLK | Clock |
| X0D11 | MOSI | Master Out Slave In (Data) |

Figure 12:
SPI slave pins

The xCORE Tile expects each byte to be transferred with the *least-significant bit first*. The pins used for SPI boot are hardcoded in the boot ROM and cannot be changed. If required, an SPI boot program can be burned into OTP that uses different pins.

8.4 Boot from xConnect Link

If set to boot from an xConnect Link, the processor enables its link(s) around 2 us after the boot process starts. Enabling the Link switches off the pull-down resistors on the link, drives all the TX wires low (the initial state for the Link), and monitors the RX pins for boot-traffic; they must be low at this stage. If the internal pull-down is too weak to drain any residual charge, external pull-downs of 10K may be required on those pins.

The boot-rom on the core will then:

1. Allocate channel-end 0.
2. Input a word on channel-end 0. It will use this word as a channel to acknowledge the boot. Provide the null-channel-end 0x0000FF02 if no acknowledgment is required.
3. Input the boot image specified above, including the CRC.
4. Input an END control token.
5. Output an END control token to the channel-end received in step 2.
6. Free channel-end 0.
7. Jump to the loaded code.

PRELIMINARY

8.5 Boot from OTP

If an xCORE tile is set to use secure boot (see Figure 8), the boot image is read from address 0 of the OTP memory in the tile's security module.

This feature can be used to implement a secure bootloader which loads an encrypted image from external flash, decrypts and CRC checks it with the processor, and discontinues the boot process if the decryption or CRC check fails. XMOS provides a default secure bootloader that can be written to the OTP along with secret decryption keys.

Each tile has its own individual OTP memory, and hence some tiles can be booted from OTP while others are booted from SPI or the channel interface. This enables systems to be partially programmed, dedicating one or more tiles to perform a particular function, leaving the other tiles user-programmable.

8.6 Security register

The security register enables security features on the xCORE tile. The features shown in Figure 13 provide a strong level of protection and are sufficient for providing strong IP security.

| Feature | Bit | Description |
|---------------------|--------|--|
| Disable JTAG | 0 | The JTAG interface is disabled, making it impossible for the tile state or memory content to be accessed via the JTAG interface. |
| Disable Link access | 1 | Other tiles are forbidden access to the processor state via the system switch. Disabling both JTAG and Link access transforms an xCORE Tile into a "secure island" with other tiles free for non-secure user application code. |
| Secure Boot | 5 | The xCORE Tile is forced to boot from address 0 of the OTP, allowing the xCORE Tile boot ROM to be bypassed (see §8). |
| Redundant rows | 7 | Enables redundant rows in OTP. |
| Sector Lock 0 | 8 | Disable programming of OTP sector 0. |
| Sector Lock 1 | 9 | Disable programming of OTP sector 1. |
| Sector Lock 2 | 10 | Disable programming of OTP sector 2. |
| Sector Lock 3 | 11 | Disable programming of OTP sector 3. |
| OTP Master Lock | 12 | Disable OTP programming completely: disables updates to all sectors and security register. |
| Disable JTAG-OTP | 13 | Disable all (read & write) access from the JTAG interface to this OTP. |
| | 21..15 | General purpose software accessible security register available to end-users. |
| | 31..22 | General purpose user programmable JTAG UserID code extension. |

Figure 13:
Security register features

9 Memory

9.1 OTP

The xCORE Tile integrates 8 KB one-time programmable (OTP) memory along with a security register that configures system wide security features. The OTP holds data in four sectors each containing 512 rows of 32 bits which can be used to implement secure bootloaders and store encryption keys. Data for the security register is loaded from the OTP on power up. All additional data in OTP is copied from the OTP to SRAM and executed first on the processor.

The OTP memory is programmed using three special I/O ports: the OTP address port is a 16-bit port with resource ID 0x100200, the OTP data is written via a 32-bit port with resource ID 0x200100, and the OTP control is on a 16-bit port with ID 0x100300. Programming is performed through `libotp` and `xburn`.

9.2 SRAM

The xCORE Tile integrates a single 128KBSRAM bank for both instructions and data. All internal memory is 32 bits wide, and instructions are either 16-bit or 32-bit. Byte (8-bit), half-word (16-bit) or word (32-bit) accesses are supported and are executed within one tile clock cycle. There is no dedicated external memory interface, although data memory can be expanded through appropriate use of the ports.

10 JTAG

The JTAG module can be used for loading programs, boundary scan testing, in-circuit source-level debugging and programming the OTP memory.

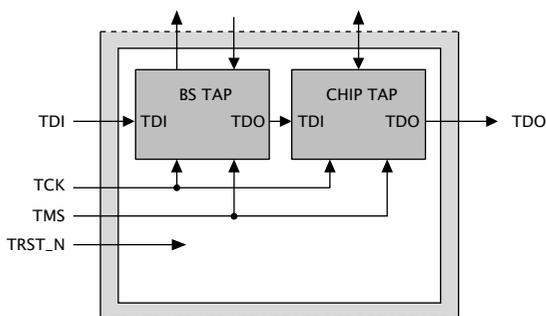

Figure 14:
JTAG chain
structure

The JTAG chain structure is illustrated in Figure 14. Directly after reset, two TAP controllers are present in the JTAG chain: the boundary scan TAP and the chip TAP. The boundary scan TAP is a standard 1149.1 compliant TAP that can be used for

PRELIMINARY

example, a 4.7Ω resistor and 100 nF multi-layer ceramic capacitor) is recommended on this pin.

The following ground pins are provided:

- ▶ PLL_AGND for PLL_AVDD
- ▶ GND for all other supplies

All ground pins must be connected directly to the board ground.

The VDD and VDDIO supplies should be decoupled close to the chip by several 100 nF low inductance multi-layer ceramic capacitors between the supplies and GND (for example, 4x100nF 0402 low inductance MLCCs per supply rail). The ground side of the decoupling capacitors should have as short a path back to the GND pins as possible. A bulk decoupling capacitor of at least 10 μF should be placed on each of these supplies.

RST_N is an active-low asynchronous-assertion global reset signal. Following a reset, the PLL re-establishes lock after which the device boots up according to the boot mode (see §8). RST_N and must be asserted low during and after power up for 100 ns.

11.1 Land patterns and solder stencils

The land pattern recommendations in this document are based on a RoHS compliant process and derived, where possible, from the nominal *Generic Requirements for Surface Mount Design and Land Pattern Standards IPC-7351B* specifications. This standard aims to achieve desired targets of heel, toe and side fillets for solder-joints.

Solder paste and ground via recommendations are based on our engineering and development kit board production. They have been found to work and optimized as appropriate to achieve a high yield. The size, type and number of vias used in the center pad affects how much solder wicks down the vias during reflow. This in turn, along with solder paster coverage, affects the final assembled package height. These factors should be taken into account during design and manufacturing of the PCB.

The following land patterns and solder paste contains recommendations. Final land pattern and solder paste decisions are the responsibility of the customer. These should be tuned during manufacture to suit the manufacturing process.

The package is a 128 pin Thin Quad Flat Pack package with exposed heat slug on a 0.4mm pitch. An example land pattern is shown in Figure 17.

Pad widths and spacings are such that solder mask can still be applied between the pads using standard design rules. This is recommended to reduce solder shorts.

The center pad solder paste level needs to be controlled so the device sits the correct height from the circuit board. For the 128 pin TQFP package, a 3x3 array of squares for solder paste is recommended as shown in Figure 18. This gives a paste level of 56%.

PRELIMINARY

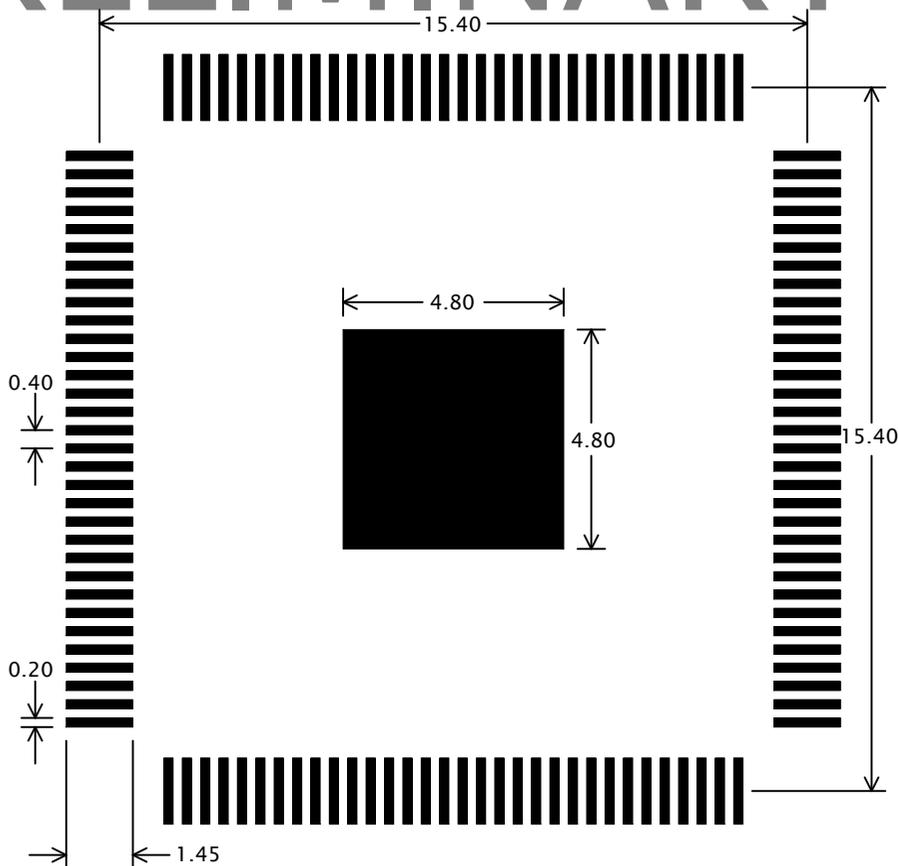

Figure 17:
Example land pattern

11.2 Ground and Thermal Vias

Vias under the heat slug into the ground plane of the PCB are recommended for a low inductance ground connection and good thermal performance. A 3 x 3 grid of vias, with a 0.6mm diameter annular ring and a 0.3mm drill, equally spaced across the heat slug, would be suitable.

11.3 Moisture Sensitivity

XMOS devices are, like all semiconductor devices, susceptible to moisture absorption. When removed from the sealed packaging, the devices slowly absorb moisture from the surrounding environment. If the level of moisture present in the device is too high during reflow, damage can occur due to the increased internal vapour pressure of moisture. Example damage can include bond wire damage, die lifting, internal or external package cracks and/or delamination.

PRELIMINARY

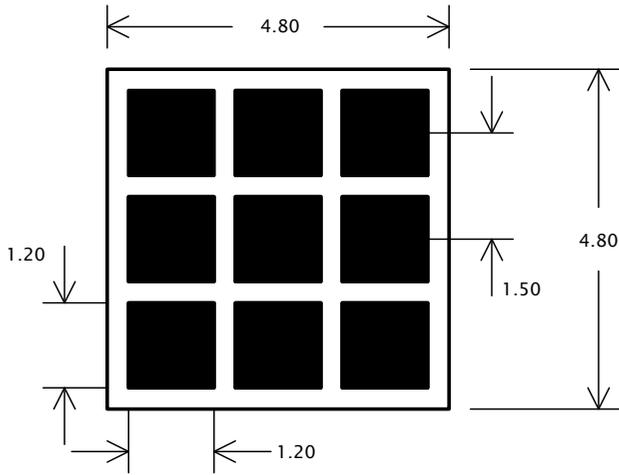

Figure 18:
Solder stencil
for centre
pad

All XMOS devices are Moisture Sensitivity Level (MSL) 3 - devices have a shelf life of 168 hours between removal from the packaging and reflow, provided they are stored below 30C and 60% RH. If devices have exceeded these values or an included moisture indicator card shows excessive levels of moisture, then the parts should be baked as appropriate before use. This is based on information from *Joint IPC/JEDEC Standard For Moisture/Reflow Sensitivity Classification For Nonhermetic Solid State Surface-Mount Devices J-STD-020* Revision D.

12 DC and Switching Characteristics

12.1 Operating Conditions

| Symbol | Parameter | MIN | TYP | MAX | UNITS | Notes |
|----------|----------------------------------|------|------|------|-------|-------|
| VDD | Tile DC supply voltage | 0.95 | 1.00 | 1.05 | V | |
| VDDIOL | I/O supply voltage | 2.25 | 3.30 | 3.60 | V | |
| VDDIOR | I/O supply voltage | 2.25 | 3.30 | 3.60 | V | |
| VDDIOT | I/O supply voltage | 2.25 | 3.30 | 3.60 | V | |
| PLL_AVDD | PLL analog supply | 0.95 | 1.00 | 1.05 | V | |
| OTP_VCC | OTP supply voltage | 3.00 | 3.30 | 3.60 | V | |
| CI | xCORE Tile I/O load capacitance | | | 25 | pF | |
| Ta | Ambient operating temperature () | 0 | | 70 | °C | |
| | Ambient operating temperature () | -40 | | 85 | °C | |
| | Ambient operating temperature () | -40 | | 105 | °C | |
| Tj | Junction temperature | | | 125 | °C | |
| Tstg | Storage temperature | -65 | | 150 | °C | |

Figure 19:
Operating conditions

12.2 DC Characteristics

| Symbol | Parameter | MIN | TYP | MAX | UNITS | Notes |
|--------|----------------------|-------|-----|------|-------|-------|
| V(IH) | Input high voltage | 2.00 | | 3.60 | V | A |
| V(IL) | Input low voltage | -0.30 | | 0.70 | V | A |
| V(OH) | Output high voltage | 2.00 | | | V | B, C |
| V(OL) | Output low voltage | | | 0.60 | V | B, C |
| R(PU) | Pull-up resistance | | 35K | | Ω | D |
| R(PD) | Pull-down resistance | | 35K | | Ω | D |

Figure 20:
DC characteristics

A All pins except power supply pins.

B Pins X1D40, X1D41, X1D42, X1D43, X1D26, and X1D27 are nominal 8 mA drivers, the remainder of the general-purpose I/Os are 4 mA.

C Measured with 4 mA drivers sourcing 4 mA, 8 mA drivers sourcing 8 mA.

D Used to guarantee logic state for an I/O when high impedance. The internal pull-ups/pull-downs should not be used to pull external circuitry.

12.3 ESD Stress Voltage

| Symbol | Parameter | MIN | TYP | MAX | UNITS | Notes |
|--------|------------------|-------|-----|------|-------|-------|
| HBM | Human body model | -2.00 | | 2.00 | KV | |
| MM | Machine model | -200 | | 200 | V | |

Figure 21:
ESD stress voltage

PRELIMINARY

12.4 Reset Timing

Figure 22:
Reset timing

| Symbol | Parameters | MIN | TYP | MAX | UNITS | Notes |
|---------|---------------------|-----|-----|-----|-------|-------|
| T(RST) | Reset pulse width | 5 | | | us | |
| T(INIT) | Initialization time | | | 150 | µs | A |

A Shows the time taken to start booting after RST_N has gone high.

12.5 Power Consumption

Figure 23:
xCORE Tile currents

| Symbol | Parameter | MIN | TYP | MAX | UNITS | Notes |
|-----------|------------------------|-----|-----|-----|---------|------------|
| I(DDCQ) | Quiescent VDD current | | TBC | | mA | A, B, C |
| PD | Tile power dissipation | | TBC | | µW/MIPS | A, D, E, F |
| IDD | Active VDD current () | | TBC | TBC | mA | A, G |
| | Active VDD current () | | TBC | TBC | mA | A, H |
| I(ADDPLL) | PLL_AVDD current | | | TBC | mA | I |

A Use for budgetary purposes only.

B Assumes typical tile and I/O voltages with no switching activity.

C Includes PLL current.

D Assumes typical tile and I/O voltages with nominal switching activity.

E Assumes 1 MHz = 1 MIPS.

F PD(TYP) value is the usage power consumption under typical operating conditions.

G Measurement conditions: VDD = 1.0 V, VDDIO = 3.3 V, 25 °C, 400 MHz, average device resource usage.

H Measurement conditions: VDD = 1.0 V, VDDIO = 3.3 V, 25 °C, 500 MHz, average device resource usage.

I PLL_AVDD = 1.0 V



The tile power consumption of the device is highly application dependent and should be used for budgetary purposes only.

More detailed power analysis can be found in the XS1-L Power Consumption document,

12.6 Clock

Figure 24:
Clock

| Symbol | Parameter | MIN | TYP | MAX | UNITS | Notes |
|--------|-------------------------------|------|-----|-----|-------|-------|
| f | Frequency | 9 | 25 | 25 | MHz | |
| SR | Slew rate | 0.10 | | | V/ns | |
| TJ(LT) | Long term jitter (pk-pk) | | | 2 | % | A |
| f(MAX) | Processor clock frequency () | | | 400 | MHz | B |
| | Processor clock frequency () | | | 500 | MHz | B |

A Percentage of CLK period.

B Assumes typical tile and I/O voltages with nominal activity.

Further details can be found in the XS1-L Clock Frequency Control document,

PRELIMINARY

12.7 xCORE Tile I/O AC Characteristics

Figure 25:
I/O AC characteristics

| Symbol | Parameter | MIN | TYP | MAX | UNITS | Notes |
|--------------|---|-----|-----|-----|-------|-------|
| T(XOVALID) | Input data valid window | 8 | | | ns | |
| T(XOINVALID) | Output data invalid window | 9 | | | ns | |
| T(XIFMAX) | Rate at which data can be sampled with respect to an external clock | | | 60 | MHz | |

The input valid window parameter relates to the capability of the device to capture data input to the chip with respect to an external clock source. It is calculated as the sum of the input setup time and input hold time with respect to the external clock as measured at the pins. The output invalid window specifies the time for which an output is invalid with respect to the external clock. Note that these parameters are specified as a window rather than absolute numbers since the device provides functionality to delay the incoming clock with respect to the incoming data.

Information on interfacing to high-speed synchronous interfaces can be found in the XS1 Port I/O Timing document, [X5821](#).

12.8 xConnect Link Performance

Figure 26:
Link performance

| Symbol | Parameter | MIN | TYP | MAX | UNITS | Notes |
|------------|--------------------------------|-----|-----|-----|--------|-------|
| B(2blinkP) | 2b link bandwidth (packetized) | | | 87 | MBit/s | A, B |
| B(5blinkP) | 5b link bandwidth (packetized) | | | 217 | MBit/s | A, B |
| B(2blinkS) | 2b link bandwidth (streaming) | | | 100 | MBit/s | B |
| B(5blinkS) | 5b link bandwidth (streaming) | | | 250 | MBit/s | B |

A Assumes 32-byte packet in 3-byte header mode. Actual performance depends on size of the header and payload.

B 7.5 ns symbol time.

The asynchronous nature of links means that the relative phasing of CLK clocks is not important in a multi-clock system, providing each meets the required stability criteria.

12.9 JTAG Timing

Figure 27:
JTAG timing

| Symbol | Parameter | MIN | TYP | MAX | UNITS | Notes |
|----------|-------------------------------|-----|-----|-----|-------|-------|
| f(TCK_D) | TCK frequency (debug) | | | 18 | MHz | |
| f(TCK_B) | TCK frequency (boundary scan) | | | 10 | MHz | |
| T(SETUP) | TDO to TCK setup time | 5 | | | ns | A |
| T(HOLD) | TDO to TCK hold time | 5 | | | ns | A |
| T(DELAY) | TCK to output delay | | | 15 | ns | B |

A Timing applies to TMS and TDI inputs.

B Timing applies to TDO output from negative edge of TCK.

All JTAG operations are synchronous to TCK apart from the global asynchronous reset TRST_N.

PRELIMINARY

13 Package Information

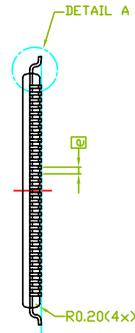
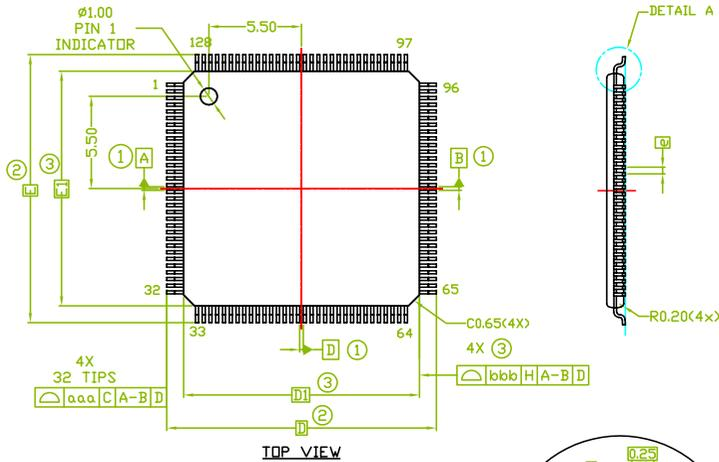

| SYMBOL | Min. | Nom. | Max. |
|--------|-----------|------|------|
| A | - | - | 1.20 |
| A1 | 0.05 | - | 0.15 |
| A2 | 0.95 | 1.00 | 1.05 |
| b | 0.13 | 0.18 | 0.23 |
| b1 | 0.13 | 0.18 | 0.19 |
| D | 16.00 BSC | | |
| D1 | 14.00 BSC | | |
| e | 0.40 BSC | | |
| E | 16.00 BSC | | |
| E1 | 14.00 BSC | | |
| θ | 0° | 3.5° | 7° |
| θ1 | 0° | - | - |
| θ2 | 11° | 12° | 13° |
| θ3 | 11° | 12° | 13° |
| c | 0.09 | - | 0.20 |
| e1 | 0.09 | - | 0.18 |
| L | 0.45 | 0.60 | 0.75 |
| L1 | 1.00 REF | | |
| R1 | 0.08 | - | - |
| R2 | 0.08 | - | 0.20 |

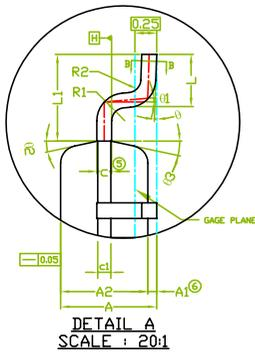
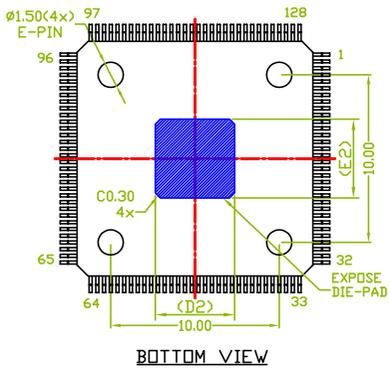

| REF | TOLERANCES OF FORM AND POSITION |
|-----|---------------------------------|
| aaa | 0.20 |
| bbb | 0.20 |
| ccc | 0.08 |
| ddd | 0.07 |

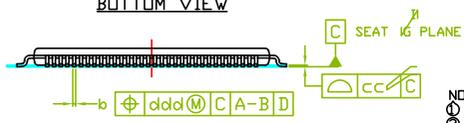

| LF Ref# | Symbol | Min | Nom | Max |
|------------|--------|------|------|------|
| L-17-09011 | D2 | 4.60 | 4.70 | 4.80 |
| | E2 | 4.60 | 4.70 | 4.80 |

NOTE :

- DATUM A-B AND D TO DETERMINE AT DATUM PLANE H.
- TO BE DETERMINED AT SEATING DATUM PLAN C.
- DIMENSION D1 AND E1 DO NOT INCLUDE MOLD PROTRUSIONS. ALLOWABLE PROTRUSION IS 0.25 mm PER SIDE. S1 AND E1 ARE MAXIMUM PLASTIC BODY SIZE DIMENSION INCLUDING MOLD MISMATCH.
- DIMENSION b DO NOT INCLUDE DAMBAR PROTRUSION. ALLOWABLE DAMBAR PROTRUSION SHALL NOT CAUSE THE LEAD WIDTH TO EXCEED THE MAXIMUM b DIMENSION BY MORE THAN 0.08 mm. DAMBAR CANNOT BE LOCATED ON THE LOWER RADIUS OR THE FOOT. MINIMUM SPACE BETWEEN PROTRUSION AND ADJACENT LEAD IS 0.07 mm FOR 0.4mm AND 0.5 mm PITCH PACKAGE.
- THESE DIMENSIONS APPLY TO THE FLAT SECTION OF THE BETWEEN 0.10 mm AND 0.25 mm FROM THE LEAD TIP.
- A1 IS THE DEFINED AS THE DISTANCE FROM THE SEATING PLAN TO THE LOWEST POINT ON THE PACKAGE BODY.
- PACKAGE LEAD COUNT IS NON-JEDEC STANDARD.

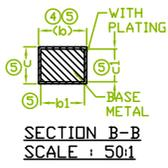

PRELIMINARY

13.1 Part Marking

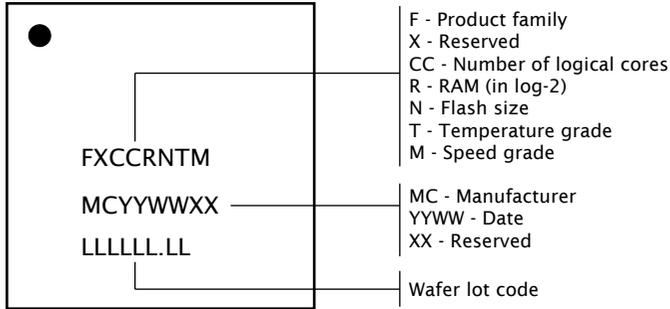

Figure 28:
Part marking
scheme

14 Ordering Information

Figure 29:
Orderable
part numbers

| Product Code | Marking | Qualification | Speed Grade |
|---------------------|-----------|---------------|-------------|
| XL208-128-TQ128-C10 | L30870C10 | Commercial | 500 MIPS |
| XL208-128-TQ128-I10 | L30870I10 | Industrial | 500 MIPS |

PRELIMINARY

Appendices

A Configuration of the XL208-128-TQ128

The device is configured through banks of registers, as shown in Figure 30.

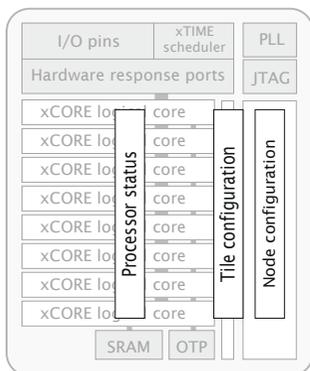

Figure 30:
Registers

The following communication sequences specify how to access those registers. Any messages transmitted contain the most significant 24 bits of the channel-end to which a response is to be sent. This comprises the node-identifier and the channel number within the node. If no response is required on a write operation, supply 24-bits with the last 8-bits set, which suppresses the reply message. Any multi-byte data is sent most significant byte first.

A.1 Accessing a processor status register

The processor status registers are accessed directly from the processor instruction set. The instructions GETPS and SETPS read and write a word. The register number should be translated into a processor-status resource identifier by shifting the register number left 8 places, and ORing it with 0x0B. Alternatively, the functions `getps(reg)` and `setps(reg,value)` can be used from XC.

A.2 Accessing an xCORE Tile configuration register

xCORE Tile configuration registers can be accessed through the interconnect using the functions `write_tile_config_reg(tileref, ...)` and `read_tile_config_reg(tile ↪ ref, ...)`, where `tileref` is the name of the xCORE Tile, e.g. `tile[1]`. These functions implement the protocols described below.

Instead of using the functions above, a channel-end can be allocated to communicate with the xCORE tile configuration registers. The destination of the channel-end should be set to `0xnnnnC20C` where `nnnnn` is the tile-identifier.

A write message comprises the following:

PRELIMINARY

| | | | | |
|----------------------|---|---------------------------|----------------|--------------------|
| control-token 192 | 24-bit response channel-end identifier | 16-bit register number | 32-bit data | control-token 1 |
|----------------------|---|---------------------------|----------------|--------------------|

The response to a write message comprises either control tokens 3 and 1 (for success), or control tokens 4 and 1 (for failure).

A read message comprises the following:

| | | | |
|----------------------|---|---------------------------|--------------------|
| control-token 193 | 24-bit response channel-end identifier | 16-bit register number | control-token 1 |
|----------------------|---|---------------------------|--------------------|

The response to the read message comprises either control token 3, 32-bit of data, and control-token 1 (for success), or control tokens 4 and 1 (for failure).

A.3 Accessing node configuration

Node configuration registers can be accessed through the interconnect using the functions `write_node_config_reg(device, ...)` and `read_node_config_reg(device, ↵ ...)`, where `device` is the name of the node. These functions implement the protocols described below.

Instead of using the functions above, a channel-end can be allocated to communicate with the node configuration registers. The destination of the channel-end should be set to `0xnnnnC30C` where `nnnn` is the node-identifier.

A write message comprises the following:

| | | | | |
|----------------------|---|---------------------------|----------------|--------------------|
| control-token 192 | 24-bit response channel-end identifier | 16-bit register number | 32-bit data | control-token 1 |
|----------------------|---|---------------------------|----------------|--------------------|

The response to a write message comprises either control tokens 3 and 1 (for success), or control tokens 4 and 1 (for failure).

A read message comprises the following:

| | | | |
|----------------------|---|---------------------------|--------------------|
| control-token 193 | 24-bit response channel-end identifier | 16-bit register number | control-token 1 |
|----------------------|---|---------------------------|--------------------|

The response to a read message comprises either control token 3, 32-bit of data, and control-token 1 (for success), or control tokens 4 and 1 (for failure).

PRELIMINARY

B Processor Status Configuration

The processor status control registers can be accessed directly by the processor using processor status reads and writes (use `getps(reg)` and `setps(reg,value)` for reads and writes).

| Number | Perm | Description |
|--------------|------|---------------------------------------|
| 0x00 | RW | RAM base address |
| 0x01 | RW | Vector base address |
| 0x02 | RW | xCORE Tile control |
| 0x03 | RO | xCORE Tile boot status |
| 0x05 | RW | Security configuration |
| 0x06 | RW | Ring Oscillator Control |
| 0x07 | RO | Ring Oscillator Value |
| 0x08 | RO | Ring Oscillator Value |
| 0x09 | RO | Ring Oscillator Value |
| 0x0A | RO | Ring Oscillator Value |
| 0x0C | RO | RAM size |
| 0x10 | DRW | Debug SSR |
| 0x11 | DRW | Debug SPC |
| 0x12 | DRW | Debug SSP |
| 0x13 | DRW | DGETREG operand 1 |
| 0x14 | DRW | DGETREG operand 2 |
| 0x15 | DRW | Debug interrupt type |
| 0x16 | DRW | Debug interrupt data |
| 0x18 | DRW | Debug core control |
| 0x20 .. 0x27 | DRW | Debug scratch |
| 0x30 .. 0x33 | DRW | Instruction breakpoint address |
| 0x40 .. 0x43 | DRW | Instruction breakpoint control |
| 0x50 .. 0x53 | DRW | Data watchpoint address 1 |
| 0x60 .. 0x63 | DRW | Data watchpoint address 2 |
| 0x70 .. 0x73 | DRW | Data breakpoint control register |
| 0x80 .. 0x83 | DRW | Resources breakpoint mask |
| 0x90 .. 0x93 | DRW | Resources breakpoint value |
| 0x9C .. 0x9F | DRW | Resources breakpoint control register |

Figure 31:
Summary

PRELIMINARY

B.1 RAM base address: 0x00

This register contains the base address of the RAM. It is initialized to 0x00040000.

0x00:
RAM base
address

| Bits | Perm | Init | Description |
|------|------|------|--|
| 31:2 | RW | | Most significant 16 bits of all addresses. |
| 1:0 | RO | - | Reserved |

B.2 Vector base address: 0x01

Base address of event vectors in each resource. On an interrupt or event, the 16 most significant bits of the destination address are provided by this register; the least significant 16 bits come from the event vector.

0x01:
Vector base
address

| Bits | Perm | Init | Description |
|-------|------|------|----------------------------------|
| 31:18 | RW | | The event and interrupt vectors. |
| 17:0 | RO | - | Reserved |

B.3 xCORE Tile control: 0x02

Register to control features in the xCORE tile

0x02:
xCORE Tile
control

| Bits | Perm | Init | Description |
|-------|------|------|--|
| 31:26 | RO | - | Reserved |
| 25:18 | RW | 0 | RGMII TX data delay value (in PLL output cycle increments) |
| 17:9 | RW | 0 | RGMII TX clock divider value. TX clk rises when counter (clocked by PLL output) reaches this value and falls when counter reaches (value»1). Value programmed into this field should be actual divide value required minus 1 |
| 8 | RW | 0 | Enable RGMII interface periph ports |
| 7:6 | RO | - | Reserved |
| 5 | RW | 0 | Select the dynamic mode (1) for the clock divider when the clock divider is enabled. In dynamic mode the clock divider is only activated when all active threads are paused. In static mode the clock divider is always enabled. |
| 4 | RW | 0 | Enable the clock divider. This divides the output of the PLL to facilitate one of the low power modes. |
| 3:0 | RO | - | Reserved |

PRELIMINARY

B.4 xCORE Tile boot status: 0x03

This read-only register describes the boot status of the xCORE tile.

| Bits | Perm | Init | Description |
|-------|------|------|---|
| 31:24 | RO | - | Reserved |
| 23:16 | RO | | Processor number. |
| 15:9 | RO | - | Reserved |
| 8 | RO | | Overwrite BOOT_MODE. |
| 7:6 | RO | - | Reserved |
| 5 | RO | | Indicates if core1 has been powered off |
| 4 | RO | | Cause the ROM to not poll the OTP for correct read levels |
| 3 | RO | | Boot ROM boots from RAM |
| 2 | RO | | Boot ROM boots from JTAG |
| 1:0 | RO | | The boot PLL mode pin value. |

0x03:
xCORE Tile
boot status

B.5 Security configuration: 0x05

Copy of the security register as read from OTP.

| Bits | Perm | Init | Description |
|-------|------|------|---|
| 31 | RW | | Disables write permission on this register |
| 30:15 | RO | - | Reserved |
| 14 | RW | | Disable access to XCore's global debug |
| 13 | RO | - | Reserved |
| 12 | RW | | lock all OTP sectors |
| 11:8 | RW | | lock bit for each OTP sector |
| 7 | RW | | Enable OTP redundancy |
| 6 | RO | - | Reserved |
| 5 | RW | | Override boot mode and read boot image from OTP |
| 4 | RW | | Disable JTAG access to the PLL/BOOT configuration registers |
| 3:1 | RO | - | Reserved |
| 0 | RW | | Disable access to XCore's JTAG debug TAP |

0x05:
Security
configuration

PRELIMINARY

B.6 Ring Oscillator Control: 0x06

There are four free-running oscillators that clock four counters. The oscillators can be started and stopped using this register. The counters should only be read when the ring oscillator has been stopped for at least 10 core clock cycles (this can be achieved by inserting two nop instructions between the SETPS and GETPS). The counter values can be read using four subsequent registers. The ring oscillators are asynchronous to the xCORE tile clock and can be used as a source of random bits.

0x06:
Ring
Oscillator
Control

| Bits | Perm | Init | Description |
|------|------|------|------------------------------------|
| 31:2 | RO | - | Reserved |
| 1 | RW | 0 | Core ring oscillator enable. |
| 0 | RW | 0 | Peripheral ring oscillator enable. |

B.7 Ring Oscillator Value: 0x07

This register contains the current count of the xCORE Tile Cell ring oscillator. This value is not reset on a system reset.

0x07:
Ring
Oscillator
Value

| Bits | Perm | Init | Description |
|-------|------|------|-------------------------------|
| 31:16 | RO | - | Reserved |
| 15:0 | RO | 0 | Ring oscillator Counter data. |

B.8 Ring Oscillator Value: 0x08

This register contains the current count of the xCORE Tile Wire ring oscillator. This value is not reset on a system reset.

0x08:
Ring
Oscillator
Value

| Bits | Perm | Init | Description |
|-------|------|------|-------------------------------|
| 31:16 | RO | - | Reserved |
| 15:0 | RO | 0 | Ring oscillator Counter data. |

B.9 Ring Oscillator Value: 0x09

This register contains the current count of the Peripheral Cell ring oscillator. This value is not reset on a system reset.

0x09:
Ring
Oscillator
Value

| Bits | Perm | Init | Description |
|-------|------|------|-------------------------------|
| 31:16 | RO | - | Reserved |
| 15:0 | RO | 0 | Ring oscillator Counter data. |

B.10 Ring Oscillator Value: 0x0A

This register contains the current count of the Peripheral Wire ring oscillator. This value is not reset on a system reset.

0x0A:
Ring
Oscillator
Value

| Bits | Perm | Init | Description |
|-------|------|------|-------------------------------|
| 31:16 | RO | - | Reserved |
| 15:0 | RO | 0 | Ring oscillator Counter data. |

B.11 RAM size: 0x0C

The size of the RAM in bytes

0x0C:
RAM size

| Bits | Perm | Init | Description |
|------|------|------|--|
| 31:2 | RO | | Most significant 16 bits of all addresses. |
| 1:0 | RO | - | Reserved |

B.12 Debug SSR: 0x10

This register contains the value of the SSR register when the debugger was called.

PRELIMINARY

| Bits | Perm | Init | Description |
|-------|------|------|--|
| 31:11 | RO | - | Reserved |
| 10 | DRW | | Address space indentifier |
| 9 | DRW | | Determines the issue mode (DI bit) upon Kernel Entry after Exception or Interrupt. |
| 8 | RO | | Determines the issue mode (DI bit). |
| 7 | DRW | | When 1 the thread is in fast mode and will continually issue. |
| 6 | DRW | | When 1 the thread is paused waiting for events, a lock or another resource. |
| 5 | RO | - | Reserved |
| 4 | DRW | | 1 when in kernel mode. |
| 3 | DRW | | 1 when in an interrupt handler. |
| 2 | DRW | | 1 when in an event enabling sequence. |
| 1 | DRW | | When 1 interrupts are enabled for the thread. |
| 0 | DRW | | When 1 events are enabled for the thread. |

0x10:
Debug SSR

B.13 Debug SPC: 0x11

This register contains the value of the SPC register when the debugger was called.

0x11:
Debug SPC

| Bits | Perm | Init | Description |
|------|------|------|-------------|
| 31:0 | DRW | | Value. |

B.14 Debug SSP: 0x12

This register contains the value of the SSP register when the debugger was called.

0x12:
Debug SSP

| Bits | Perm | Init | Description |
|------|------|------|-------------|
| 31:0 | DRW | | Value. |

B.15 DGETREG operand 1: 0x13

The resource ID of the logical core whose state is to be read.

PRELIMINARY

0x13:
DGETREG
operand 1

| Bits | Perm | Init | Description |
|------|------|------|--------------------------|
| 31:8 | RO | - | Reserved |
| 7:0 | DRW | | Thread number to be read |

B.16 DGETREG operand 2: 0x14

Register number to be read by DGETREG

0x14:
DGETREG
operand 2

| Bits | Perm | Init | Description |
|------|------|------|----------------------------|
| 31:5 | RO | - | Reserved |
| 4:0 | DRW | | Register number to be read |

B.17 Debug interrupt type: 0x15

Register that specifies what activated the debug interrupt.

0x15:
Debug
interrupt type

| Bits | Perm | Init | Description |
|-------|------|------|--|
| 31:18 | RO | - | Reserved |
| 17:16 | DRW | | Number of the hardware breakpoint/watchpoint which caused the interrupt (always 0 for =HOST= and =DCALL=). If multiple breakpoints/watchpoints trigger at once, the lowest number is taken. |
| 15:8 | DRW | | Number of thread which caused the debug interrupt (always 0 in the case of =HOST=). |
| 7:3 | RO | - | Reserved |
| 2:0 | DRW | 0 | Indicates the cause of the debug interrupt 1: Host initiated a debug interrupt through JTAG 2: Program executed a DCALL instruction 3: Instruction breakpoint 4: Data watch point 5: Resource watch point |

B.18 Debug interrupt data: 0x16

On a data watchpoint, this register contains the effective address of the memory operation that triggered the debugger. On a resource watchpoint, it contains the resource identifier.

PRELIMINARY

0x16:
Debug
interrupt data

| Bits | Perm | Init | Description |
|------|------|------|-------------|
| 31:0 | DRW | | Value. |

B.19 Debug core control: 0x18

This register enables the debugger to temporarily disable logical cores. When returning from the debug interrupts, the cores set in this register will not execute. This enables single stepping to be implemented.

0x18:
Debug core
control

| Bits | Perm | Init | Description |
|------|------|------|---|
| 31:8 | RO | - | Reserved |
| 7:0 | DRW | | 1-hot vector defining which threads are stopped when not in debug mode. Every bit which is set prevents the respective thread from running. |

B.20 Debug scratch: 0x20 .. 0x27

A set of registers used by the debug ROM to communicate with an external debugger, for example over JTAG. This is the same set of registers as the [Debug Scratch registers in the xCORE tile configuration](#).

0x20 .. 0x27:
Debug
scratch

| Bits | Perm | Init | Description |
|------|------|------|-------------|
| 31:0 | DRW | | Value. |

B.21 Instruction breakpoint address: 0x30 .. 0x33

This register contains the address of the instruction breakpoint. If the PC matches this address, then a debug interrupt will be taken. There are four instruction breakpoints that are controlled individually.

0x30 .. 0x33:
Instruction
breakpoint
address

| Bits | Perm | Init | Description |
|------|------|------|-------------|
| 31:0 | DRW | | Value. |

PRELIMINARY

B.22 Instruction breakpoint control: 0x40 .. 0x43

This register controls which logical cores may take an instruction breakpoint, and under which condition.

| Bits | Perm | Init | Description |
|-------|------|------|--|
| 31:24 | RO | - | Reserved |
| 23:16 | DRW | 0 | A bit for each thread in the machine allowing the breakpoint to be enabled individually for each thread. |
| 15:2 | RO | - | Reserved |
| 1 | DRW | 0 | When 0 break when PC == IBREAK_ADDR. When 1 = break when PC != IBREAK_ADDR. |
| 0 | DRW | 0 | When 1 the instruction breakpoint is enabled. |

0x40 .. 0x43:
Instruction
breakpoint
control

B.23 Data watchpoint address 1: 0x50 .. 0x53

This set of registers contains the first address for the four data watchpoints.

0x50 .. 0x53:
Data
watchpoint
address 1

| Bits | Perm | Init | Description |
|------|------|------|-------------|
| 31:0 | DRW | | Value. |

B.24 Data watchpoint address 2: 0x60 .. 0x63

This set of registers contains the second address for the four data watchpoints.

0x60 .. 0x63:
Data
watchpoint
address 2

| Bits | Perm | Init | Description |
|------|------|------|-------------|
| 31:0 | DRW | | Value. |

B.25 Data breakpoint control register: 0x70 .. 0x73

This set of registers controls each of the four data watchpoints.

0x70 .. 0x73:
Data
breakpoint
control
register

| Bits | Perm | Init | Description |
|-------|------|------|--|
| 31:24 | RO | - | Reserved |
| 23:16 | DRW | 0 | A bit for each thread in the machine allowing the breakpoint to be enabled individually for each thread. |
| 15:3 | RO | - | Reserved |
| 2 | DRW | 0 | When 1 the breakpoints will be be triggered on loads. |
| 1 | DRW | 0 | Determines the break condition: 0 = A AND B, 1 = A OR B. |
| 0 | DRW | 0 | When 1 the instruction breakpoint is enabled. |

B.26 Resources breakpoint mask: 0x80 .. 0x83

This set of registers contains the mask for the four resource watchpoints.

0x80 .. 0x83:
Resources
breakpoint
mask

| Bits | Perm | Init | Description |
|------|------|------|-------------|
| 31:0 | DRW | | Value. |

B.27 Resources breakpoint value: 0x90 .. 0x93

This set of registers contains the value for the four resource watchpoints.

0x90 .. 0x93:
Resources
breakpoint
value

| Bits | Perm | Init | Description |
|------|------|------|-------------|
| 31:0 | DRW | | Value. |

B.28 Resources breakpoint control register: 0x9C .. 0x9F

This set of registers controls each of the four resource watchpoints.

PRELIMINARY

0x9C .. 0x9F:
Resources
breakpoint
control
register

| Bits | Perm | Init | Description |
|-------|------|------|--|
| 31:24 | RO | - | Reserved |
| 23:16 | DRW | 0 | A bit for each thread in the machine allowing the breakpoint to be enabled individually for each thread. |
| 15:2 | RO | - | Reserved |
| 1 | DRW | 0 | When 0 break when condition A is met. When 1 = break when condition B is met. |
| 0 | DRW | 0 | When 1 the instruction breakpoint is enabled. |

C Tile Configuration

The xCORE Tile control registers can be accessed using configuration reads and writes (use `write_tile_config_reg(tileref, ...)` and `read_tile_config_reg(tileref, ...)` for reads and writes).

| Number | Perm | Description |
|--------------|------|--|
| 0x00 | CRO | Device identification |
| 0x01 | CRO | xCORE Tile description 1 |
| 0x02 | CRO | xCORE Tile description 2 |
| 0x04 | CRW | Control PSwitch permissions to debug registers |
| 0x05 | CRW | Cause debug interrupts |
| 0x06 | CRW | xCORE Tile clock divider |
| 0x07 | CRO | Security configuration |
| 0x20 .. 0x27 | CRW | Debug scratch |
| 0x40 | CRO | PC of logical core 0 |
| 0x41 | CRO | PC of logical core 1 |
| 0x42 | CRO | PC of logical core 2 |
| 0x43 | CRO | PC of logical core 3 |
| 0x44 | CRO | PC of logical core 4 |
| 0x45 | CRO | PC of logical core 5 |
| 0x46 | CRO | PC of logical core 6 |
| 0x47 | CRO | PC of logical core 7 |
| 0x60 | CRO | SR of logical core 0 |
| 0x61 | CRO | SR of logical core 1 |
| 0x62 | CRO | SR of logical core 2 |
| 0x63 | CRO | SR of logical core 3 |
| 0x64 | CRO | SR of logical core 4 |
| 0x65 | CRO | SR of logical core 5 |
| 0x66 | CRO | SR of logical core 6 |
| 0x67 | CRO | SR of logical core 7 |

Figure 32:
Summary

C.1 Device identification: 0x00

This register identifies the xCORE Tile

0x00:
Device
identification

| Bits | Perm | Init | Description |
|-------|------|------|--|
| 31:24 | CRO | | Processor ID of this XCore. |
| 23:16 | CRO | | Number of the node in which this XCore is located. |
| 15:8 | CRO | | XCore revision. |
| 7:0 | CRO | | XCore version. |

C.2 xCORE Tile description 1: 0x01

This register describes the number of logical cores, synchronisers, locks and channel ends available on this xCORE tile.

0x01:
xCORE Tile
description 1

| Bits | Perm | Init | Description |
|-------|------|------|--------------------------|
| 31:24 | CRO | | Number of channel ends. |
| 23:16 | CRO | | Number of the locks. |
| 15:8 | CRO | | Number of synchronisers. |
| 7:0 | RO | - | Reserved |

C.3 xCORE Tile description 2: 0x02

This register describes the number of timers and clock blocks available on this xCORE tile.

0x02:
xCORE Tile
description 2

| Bits | Perm | Init | Description |
|-------|------|------|-------------------------|
| 31:16 | RO | - | Reserved |
| 15:8 | CRO | | Number of clock blocks. |
| 7:0 | CRO | | Number of timers. |

C.4 Control PSwitch permissions to debug registers: 0x04

This register can be used to control whether the debug registers (marked with permission CRW) are accessible through the tile configuration registers. When this bit is set, write -access to those registers is disabled, preventing debugging of the xCORE tile over the interconnect.

0x04:
Control
PSwitch
permissions
to debug
registers

| Bits | Perm | Init | Description |
|------|------|------|---|
| 31 | CRW | 0 | When 1 the PSwitch is restricted to RO access to all CRW registers from SSwitch, XCore(PS_DBG_Scratch) and JTAG |
| 30:1 | RO | - | Reserved |
| 0 | CRW | 0 | When 1 the PSwitch is restricted to RO access to all CRW registers from SSwitch |

C.5 Cause debug interrupts: 0x05

This register can be used to raise a debug interrupt in this xCORE tile.

0x05:
Cause debug
interrupts

| Bits | Perm | Init | Description |
|------|------|------|---|
| 31:2 | RO | - | Reserved |
| 1 | CRW | 0 | 1 when the processor is in debug mode. |
| 0 | CRW | 0 | Request a debug interrupt on the processor. |

C.6 xCORE Tile clock divider: 0x06

This register contains the value used to divide the PLL clock to create the xCORE tile clock. The divider is enabled under control of the [tile control register](#)

0x06:
xCORE Tile
clock divider

| Bits | Perm | Init | Description |
|-------|------|------|---|
| 31 | CRW | 0 | Clock disable. Writing '1' will remove the clock to the tile. |
| 30:16 | RO | - | Reserved |
| 15:0 | CRW | 0 | Clock divider. |

C.7 Security configuration: 0x07

Copy of the security register as read from OTP.

| Bits | Perm | Init | Description |
|-------|------|------|---|
| 31 | CRO | | Disables write permission on this register |
| 30:15 | RO | - | Reserved |
| 14 | CRO | | Disable access to XCore's global debug |
| 13 | RO | - | Reserved |
| 12 | CRO | | lock all OTP sectors |
| 11:8 | CRO | | lock bit for each OTP sector |
| 7 | CRO | | Enable OTP redundancy |
| 6 | RO | - | Reserved |
| 5 | CRO | | Override boot mode and read boot image from OTP |
| 4 | CRO | | Disable JTAG access to the PLL/BOOT configuration registers |
| 3:1 | RO | - | Reserved |
| 0 | CRO | | Disable access to XCore's JTAG debug TAP |

0x07:
Security
configuration

C.8 Debug scratch: 0x20 .. 0x27

A set of registers used by the debug ROM to communicate with an external debugger, for example over the switch. This is the same set of registers as the [Debug Scratch registers in the processor status](#).

0x20 .. 0x27:
Debug
scratch

| Bits | Perm | Init | Description |
|------|------|------|-------------|
| 31:0 | CRW | | Value. |

C.9 PC of logical core 0: 0x40

Value of the PC of logical core 0.

0x40:
PC of logical
core 0

| Bits | Perm | Init | Description |
|------|------|------|-------------|
| 31:0 | CRO | | Value. |

C.10 PC of logical core 1: 0x41

Value of the PC of logical core 1.

PRELIMINARY

0x41:
PC of logical
core 1

| Bits | Perm | Init | Description |
|------|------|------|-------------|
| 31:0 | CRO | | Value. |

C.11 PC of logical core 2: 0x42

Value of the PC of logical core 2.

0x42:
PC of logical
core 2

| Bits | Perm | Init | Description |
|------|------|------|-------------|
| 31:0 | CRO | | Value. |

C.12 PC of logical core 3: 0x43

Value of the PC of logical core 3.

0x43:
PC of logical
core 3

| Bits | Perm | Init | Description |
|------|------|------|-------------|
| 31:0 | CRO | | Value. |

C.13 PC of logical core 4: 0x44

Value of the PC of logical core 4.

0x44:
PC of logical
core 4

| Bits | Perm | Init | Description |
|------|------|------|-------------|
| 31:0 | CRO | | Value. |

C.14 PC of logical core 5: 0x45

Value of the PC of logical core 5.

0x45:
PC of logical
core 5

| Bits | Perm | Init | Description |
|------|------|------|-------------|
| 31:0 | CRO | | Value. |

PRELIMINARY

C.15 PC of logical core 6: 0x46

Value of the PC of logical core 6.

0x46:
PC of logical
core 6

| Bits | Perm | Init | Description |
|------|------|------|-------------|
| 31:0 | CRO | | Value. |

C.16 PC of logical core 7: 0x47

Value of the PC of logical core 7.

0x47:
PC of logical
core 7

| Bits | Perm | Init | Description |
|------|------|------|-------------|
| 31:0 | CRO | | Value. |

C.17 SR of logical core 0: 0x60

Value of the SR of logical core 0

0x60:
SR of logical
core 0

| Bits | Perm | Init | Description |
|------|------|------|-------------|
| 31:0 | CRO | | Value. |

C.18 SR of logical core 1: 0x61

Value of the SR of logical core 1

0x61:
SR of logical
core 1

| Bits | Perm | Init | Description |
|------|------|------|-------------|
| 31:0 | CRO | | Value. |

C.19 SR of logical core 2: 0x62

Value of the SR of logical core 2

PRELIMINARY

0x62:
SR of logical
core 2

| Bits | Perm | Init | Description |
|------|------|------|-------------|
| 31:0 | CRO | | Value. |

C.20 SR of logical core 3: 0x63

Value of the SR of logical core 3

0x63:
SR of logical
core 3

| Bits | Perm | Init | Description |
|------|------|------|-------------|
| 31:0 | CRO | | Value. |

C.21 SR of logical core 4: 0x64

Value of the SR of logical core 4

0x64:
SR of logical
core 4

| Bits | Perm | Init | Description |
|------|------|------|-------------|
| 31:0 | CRO | | Value. |

C.22 SR of logical core 5: 0x65

Value of the SR of logical core 5

0x65:
SR of logical
core 5

| Bits | Perm | Init | Description |
|------|------|------|-------------|
| 31:0 | CRO | | Value. |

C.23 SR of logical core 6: 0x66

Value of the SR of logical core 6

0x66:
SR of logical
core 6

| Bits | Perm | Init | Description |
|------|------|------|-------------|
| 31:0 | CRO | | Value. |

PRELIMINARY

C.24 SR of logical core 7: 0x67

Value of the SR of logical core 7

0x67:
SR of logical
core 7

| Bits | Perm | Init | Description |
|------|------|------|-------------|
| 31:0 | CRO | | Value. |

D Node Configuration

The digital node control registers can be accessed using configuration reads and writes (use `write_node_config_reg(device, ...)` and `read_node_config_reg(device, ...)` for reads and writes).

| Number | Perm | Description |
|--------------|------|---------------------------------------|
| 0x00 | RO | Device identification |
| 0x01 | RO | System switch description |
| 0x04 | RW | Switch configuration |
| 0x05 | RW | Switch node identifier |
| 0x06 | RW | PLL settings |
| 0x07 | RW | System switch clock divider |
| 0x08 | RW | Reference clock |
| 0x09 | R | System JTAG device ID register |
| 0x0A | R | System USERCODE register |
| 0x0C | RW | Directions 0-7 |
| 0x0D | RW | Directions 8-15 |
| 0x10 | RW | Reserved |
| 0x11 | RW | Reserved. |
| 0x1F | RO | Debug source |
| 0x20 .. 0x28 | RW | Link status, direction, and network |
| 0x40 .. 0x47 | RO | PLink status and network |
| 0x80 .. 0x88 | RW | Link configuration and initialization |
| 0xA0 .. 0xA7 | RW | Static link configuration |

Figure 33:
Summary

D.1 Device identification: 0x00

This register contains version and revision identifiers and the mode-pins as sampled at boot-time.

| Bits | Perm | Init | Description |
|-------|------|------|---|
| 31:24 | RO | - | Reserved |
| 23:16 | RO | | Sampled values of BootCtl pins on Power On Reset. |
| 15:8 | RO | | SSwitch revision. |
| 7:0 | RO | | SSwitch version. |

0x00:
Device
identification

PRELIMINARY

D.2 System switch description: 0x01

This register specifies the number of processors and links that are connected to this switch.

0x01:
System
switch
description

| Bits | Perm | Init | Description |
|-------|------|------|--------------------------------------|
| 31:24 | RO | - | Reserved |
| 23:16 | RO | | Number of SLinks on the SSwitch. |
| 15:8 | RO | | Number of processors on the SSwitch. |
| 7:0 | RO | | Number of processors on the device. |

D.3 Switch configuration: 0x04

This register enables the setting of two security modes (that disable updates to the PLL or any other registers) and the header-mode.

0x04:
Switch
configuration

| Bits | Perm | Init | Description |
|------|------|------|---|
| 31 | RW | 0 | 0 = SSCTL registers have write access. 1 = SSCTL registers can not be written to. |
| 30:9 | RO | - | Reserved |
| 8 | RW | 0 | 0 = PLL_CTL_REG has write access. 1 = PLL_CTL_REG can not be written to. |
| 7:1 | RO | - | Reserved |
| 0 | RW | 0 | 0 = 2-byte headers, 1 = 1-byte headers (reset as 0). |

D.4 Switch node identifier: 0x05

This register contains the node identifier.

0x05:
Switch node
identifier

| Bits | Perm | Init | Description |
|-------|------|------|-----------------------------|
| 31:16 | RO | - | Reserved |
| 15:0 | RW | 0 | The unique ID of this node. |

D.5 PLL settings: 0x06

An on-chip PLL multiplies the input clock up to a higher frequency clock, used to clock the I/O, processor, and switch, see [Oscillator](#). Note: a write to this register will cause the tile to be reset.

PRELIMINARY

| Bits | Perm | Init | Description |
|-------|------|------|--|
| 31 | RW | | If set to 1, the chip will not be reset |
| 30 | RW | | If set to 1, the chip will not wait for the PLL to re-lock. Only use this if a gradual change is made to the PLL |
| 29 | DW | | If set to 1, set the PLL to be bypassed |
| 28 | DW | | If set to 1, set the boot mode to boot from JTAG |
| 27:26 | RO | - | Reserved |
| 25:23 | RW | | Output divider value range from 1 (8'h0) to 250 (8'hF9). P value. |
| 22:21 | RO | - | Reserved |
| 20:8 | RW | | Feedback multiplication ratio, range from 1 (8'h0) to 255 (8'hFE). M value. |
| 7 | RO | - | Reserved |
| 6:0 | RW | | Oscillator input divider value range from 1 (8'h0) to 32 (8'h0F). N value. |

0x06:
PLL settings

D.6 System switch clock divider: 0x07

Sets the ratio of the PLL clock and the switch clock.

| Bits | Perm | Init | Description |
|-------|------|------|--------------------------|
| 31:16 | RO | - | Reserved |
| 15:0 | RW | 0 | SSwitch clock generation |

0x07:
System
switch clock
divider

D.7 Reference clock: 0x08

Sets the ratio of the PLL clock and the reference clock used by the node.

| Bits | Perm | Init | Description |
|-------|------|------|-----------------------------|
| 31:16 | RO | - | Reserved |
| 15:0 | RW | 3 | Software ref. clock divider |

0x08:
Reference
clock

PRELIMINARY

D.8 System JTAG device ID register: 0x09

| Bits | Perm | Init | Description |
|-------|------|------|-------------|
| 31:28 | RO | | |
| 27:12 | RO | | |
| 11:1 | RO | | |
| 0 | RO | | |

0x09:
System JTAG
device ID
register

D.9 System USERCODE register: 0x0A

| Bits | Perm | Init | Description |
|-------|------|------|--|
| 31:18 | RO | | JTAG USERCODE value programmed into OTP SR |
| 17:0 | RO | | metal fixable ID code |

0x0A:
System
USERCODE
register

D.10 Directions 0-7: 0x0C

This register contains eight directions, for packets with a mismatch in bits 7..0 of the node-identifier. The direction in which a packet will be routed is governed by the most significant mismatching bit.

| Bits | Perm | Init | Description |
|-------|------|------|---|
| 31:28 | RW | 0 | The direction for packets whose dimension is 7. |
| 27:24 | RW | 0 | The direction for packets whose dimension is 6. |
| 23:20 | RW | 0 | The direction for packets whose dimension is 5. |
| 19:16 | RW | 0 | The direction for packets whose dimension is 4. |
| 15:12 | RW | 0 | The direction for packets whose dimension is 3. |
| 11:8 | RW | 0 | The direction for packets whose dimension is 2. |
| 7:4 | RW | 0 | The direction for packets whose dimension is 1. |
| 3:0 | RW | 0 | The direction for packets whose dimension is 0. |

0x0C:
Directions
0-7

D.11 Directions 8-15: 0x0D

This register contains eight directions, for packets with a mismatch in bits 15..8 of the node-identifier. The direction in which a packet will be routed is governed by the most significant mismatching bit.

PRELIMINARY

| Bits | Perm | Init | Description |
|-------|------|------|---|
| 31:28 | RW | 0 | The direction for packets whose dimension is F. |
| 27:24 | RW | 0 | The direction for packets whose dimension is E. |
| 23:20 | RW | 0 | The direction for packets whose dimension is D. |
| 19:16 | RW | 0 | The direction for packets whose dimension is C. |
| 15:12 | RW | 0 | The direction for packets whose dimension is B. |
| 11:8 | RW | 0 | The direction for packets whose dimension is A. |
| 7:4 | RW | 0 | The direction for packets whose dimension is 9. |
| 3:0 | RW | 0 | The direction for packets whose dimension is 8. |

0x0D:
Directions
8-15

D.12 Reserved: 0x10

Reserved.

| Bits | Perm | Init | Description |
|------|------|------|-------------|
| 31:2 | RO | - | Reserved |
| 1 | RW | 0 | Reserved. |
| 0 | RW | 0 | Reserved. |

0x10:
Reserved

D.13 Reserved.: 0x11

Reserved.

| Bits | Perm | Init | Description |
|------|------|------|-------------|
| 31:2 | RO | - | Reserved |
| 1 | RW | 0 | Reserved. |
| 0 | RW | 0 | Reserved. |

0x11:
Reserved.

D.14 Debug source: 0x1F

Contains the source of the most recent debug event.

PRELIMINARY

0x1F:
Debug source

| Bits | Perm | Init | Description |
|------|------|------|---|
| 31:5 | RO | - | Reserved |
| 4 | RW | | Reserved. |
| 3:2 | RO | - | Reserved |
| 1 | RW | | If set, XCore1 is the source of last GlobalDebug event. |
| 0 | RW | | If set, XCore0 is the source of last GlobalDebug event. |

D.15 Link status, direction, and network: 0x20 .. 0x28

These registers contain status information for low level debugging (read-only), the network number that each link belongs to, and the direction that each link is part of. The registers control links 0..7.

0x20 .. 0x28:
Link status,
direction, and
network

| Bits | Perm | Init | Description |
|-------|------|------|---|
| 31:26 | RO | - | Reserved |
| 25:24 | RO | | Identify the SRC_TARGET type 0 - SLink, 1 - PLink, 2 - SSCTL, 3 - Undefine. |
| 23:16 | RO | | When the link is in use, this is the destination link number to which all packets are sent. |
| 15:12 | RO | - | Reserved |
| 11:8 | RW | 0 | The direction that this link operates in. |
| 7:6 | RO | - | Reserved |
| 5:4 | RW | 0 | Determines the network to which this link belongs, reset as 0. |
| 3 | RO | - | Reserved |
| 2 | RO | | 1 when the current packet is considered junk and will be thrown away. |
| 1 | RO | | 1 when the dest side of the link is in use. |
| 0 | RO | | 1 when the source side of the link is in use. |

D.16 PLink status and network: 0x40 .. 0x47

These registers contain status information and the network number that each processor-link belongs to.

PRELIMINARY

| Bits | Perm | Init | Description |
|-------|------|------|---|
| 31:26 | RO | - | Reserved |
| 25:24 | RO | | Identify the SRC_TARGET type 0 - SLink, 1 - PLink, 2 - SSCTL, 3 - Undefine. |
| 23:16 | RO | | When the link is in use, this is the destination link number to which all packets are sent. |
| 15:6 | RO | - | Reserved |
| 5:4 | RW | 0 | Determines the network to which this link belongs, reset as 0. |
| 3 | RO | - | Reserved |
| 2 | RO | | 1 when the current packet is considered junk and will be thrown away. |
| 1 | RO | | 1 when the dest side of the link is in use. |
| 0 | RO | | 1 when the source side of the link is in use. |

0x40 .. 0x47:
PLink status
and network

D.17 Link configuration and initialization: 0x80 .. 0x88

These registers contain configuration and debugging information specific to external links. The link speed and width can be set, the link can be initialized, and the link status can be monitored. The registers control links 0..7.

| Bits | Perm | Init | Description |
|-------|------|------|---|
| 31 | RW | | Write to this bit with '1' will enable the XLink, writing '0' will disable it. This bit controls the muxing of ports with overlapping xlinks. |
| 30 | RW | 0 | 0: operate in 2 wire mode; 1: operate in 5 wire mode |
| 29:28 | RO | - | Reserved |
| 27 | RO | | Rx buffer overflow or illegal token encoding received. |
| 26 | RO | 0 | This end of the xlink has issued credit to allow the remote end to transmit |
| 25 | RO | 0 | This end of the xlink has credit to allow it to transmit. |
| 24 | WO | | Clear this end of the xlink's credit and issue a HELLO token. |
| 23 | WO | | Reset the receiver. The next symbol that is detected will be the first symbol in a token. |
| 22 | RO | - | Reserved |
| 21:11 | RW | 0 | Specify min. number of idle system clocks between two continuous symbols within a transmit token -1. |
| 10:0 | RW | 0 | Specify min. number of idle system clocks between two continuous transmit tokens -1. |

0x80 .. 0x88:
Link
configuration
and
initialization

PRELIMINARY

D.18 Static link configuration: 0xA0 .. 0xA7

These registers are used for static (ie, non-routed) links. When a link is made static, all traffic is forwarded to the designated channel end and no routing is attempted. The registers control links C, D, A, B, G, H, E, and F in that order.

| Bits | Perm | Init | Description |
|------|------|------|---|
| 31 | RW | 0 | Enable static forwarding. |
| 30:9 | RO | - | Reserved |
| 8 | RW | 0 | The destination processor on this node that packets received in static mode are forwarded to. |
| 7:5 | RO | - | Reserved |
| 4:0 | RW | 0 | The destination channel end on this node that packets received in static mode are forwarded to. |

0xA0 .. 0xA7:
Static link
configuration

PRELIMINARY

E Device Errata

This section describes minor operational differences from the data sheet and recommended workarounds. As device and documentation issues become known, this section will be updated the document revised.

To guarantee a logic low is seen on the pins RST_N, TRST_N, TMS, and TDI, the driving circuit should present an impedance of less than 100Ω to ground. Usually this is not a problem for CMOS drivers driving single inputs. If one or more of these inputs are placed in parallel, however, additional logic buffers may be required to guarantee correct operation.

For static inputs tied high or low, the relevant input pin should be tied directly to GND or VDDIO.

F JTAG, xSCOPE and Debugging

If you intend to design a board that can be used with the XMOS toolchain and xTAG debugger, you will need an xSYS header on your board. Figure 34 shows a decision diagram which explains what type of xSYS connectivity you need. The three subsections below explain the options in detail.

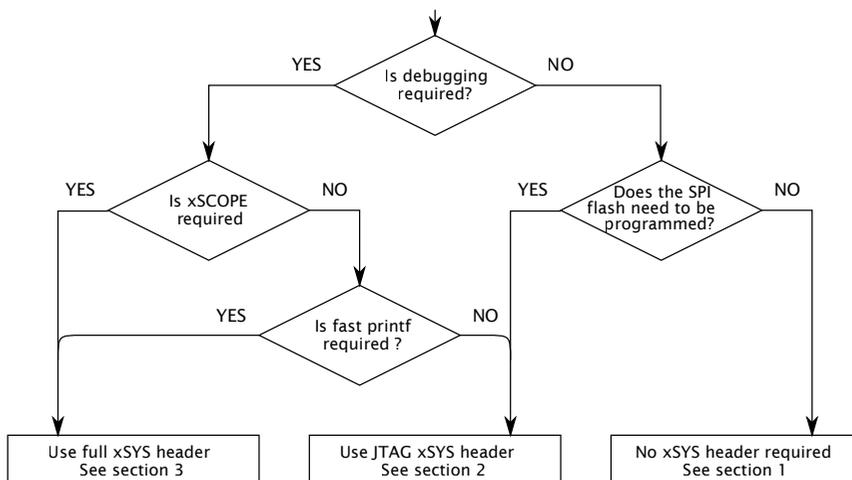

Figure 34:
Decision diagram for the xSYS header

F.1 No xSYS header

The use of an xSYS header is optional, and may not be required for volume production designs. However, the XMOS toolchain expects the xSYS header; if you do not have an xSYS header then you must provide your own method for writing to flash/OTP and for debugging.

PRELIMINARY

F.2 JTAG-only xSYS header

The xSYS header connects to an xTAG debugger, which has a 20-pin 0.1" female IDC header. The design will hence need a male IDC header. We advise to use a boxed header to guard against incorrect plug-ins. If you use a 90 degree angled header, make sure that pins 2, 4, 6, ..., 20 are along the edge of the PCB.

Connect pins 4, 8, 12, 16, 20 of the xSYS header to ground, and then connect:

- ▶ TDI to pin 5 of the xSYS header
- ▶ TMS to pin 7 of the xSYS header
- ▶ TCK to pin 9 of the xSYS header
- ▶ TDO to pin 13 of the xSYS header

The RST_N net should be open-drain, active-low, and have a pull-up to VDDIO.

F.3 Full xSYS header

For a full xSYS header you will need to connect the pins as discussed in Section F.2, and then connect a 2-wire xCONNECT Link to the xSYS header. The links can be found in the Signal description table (Section 4): they are labelled XL0, XL1, etc in the function column. The 2-wire link comprises two inputs and outputs, labelled ${}^1_{out}$, ${}^0_{out}$, ${}^0_{in}$, and ${}^1_{in}$. For example, if you choose to use XL0 for xSCOPE I/O, you need to connect up $XL0^1_{out}$, $XL0^0_{out}$, $XL0^0_{in}$, $XL0^1_{in}$ as follows:

- ▶ $XL0^1_{out}$ (X0D43) to pin 6 of the xSYS header with a 33R series resistor close to the device.
- ▶ $XL0^0_{out}$ (X0D42) to pin 10 of the xSYS header with a 33R series resistor close to the device.
- ▶ $XL0^0_{in}$ (X0D41) to pin 14 of the xSYS header.
- ▶ $XL0^1_{in}$ (X0D40) to pin 18 of the xSYS header.

G Schematics Design Check List

- This section is a checklist for use by schematics designers using the XL208-128-TQ128. Each of the following sections contains items to check for each design.

G.1 Power supplies

- VDDIO and OTP_VCC supply is within specification before the VDD (core) supply is turned on. Specifically, the VDDIO and OTP_VCC supply is within specification before VDD (core) reaches 0.4V (Section 11).
- The VDD (core) supply ramps monotonically (rises constantly) from 0V to its final value (0.95V - 1.05V) within 10ms (Section 11).
- The VDD (core) supply is capable of supplying 300mA (Section 11).
- PLL_AVDD is filtered with a low pass filter, for example an RC filter, see Section 11

G.2 Power supply decoupling

- The design has multiple decoupling capacitors per supply, for example at least four 0402 or 0603 size surface mount capacitors of 100nF in value, per supply (Section 11).
- A bulk decoupling capacitor of at least 10uF is placed on each supply (Section 11).

G.3 Power on reset

- The RST_N and TRST_N pins are asserted (low) during or after power up. The device is not used until these resets have taken place. As the errata in the datasheets show, the internal pull-ups on these two pins can occasionally provide stronger than normal pull-up currents. For this reason, an RC type reset circuit is discouraged as behavior would be unpredictable. A voltage supervisor type reset device is recommended to guarantee a good reset. This also has the benefit of resetting the system should the relevant supply go out of specification.

G.4 Clock

- The CLK input pin is supplied with a clock with monotonic rising edges and low jitter.

PRELIMINARY

- You have chosen an input clock frequency that is supported by the device (Section 7).

G.5 Boot

- The device is connected to a QSPI flash for booting, connected to X0D01, X0D04..X0D07, and X0D10 (Section 8). If not, you must boot the device through OTP or JTAG, or set it to boot from SPI and connect a SPI flash.
- The Flash that you have chosen is supported by **xflash**, or you have created a specification file for it.

G.6 JTAG, XScope, and debugging

- You have decided as to whether you need an XSYS header or not (Section F)
- If you have not included an XSYS header, you have devised a method to program the SPI-flash or OTP (Section F).

G.7 GPIO

- You have not mapped both inputs and outputs to the same multi-bit port.
- Pins X0D04, X0D05, X0D06, and X0D07 are output only and are, during and after reset, pulled high and low appropriately (Section 8)
- Pins X2D04, X2D05, X2D06 and X2D07 are output only and during and after reset, X2D06 is pulled high and X2D04, X2D05, and X2D07 are pulled low (Section 8)

G.8 Multi device designs

Skip this section if your design only includes a single XMOS device.

- One device is connected to a SPI flash for booting.
- Devices that boot from link have MODE2 grounded and MODE3 NC. These device must have link XLB connected to a device to boot from (see 8).
- If you included an XSYS header, you have included buffers for RST_N, TRST_N, TMS, TCK, MODE2, and MODE3 (Section E).

PRELIMINARY

H PCB Layout Design Check List

- This section is a checklist for use by PCB designers using the XS2-L8A-128-TQ128. Each of the following sections contains items to check for each design.

H.1 Ground Plane

- Multiple vias (eg, 9) have been used to connect the center pad to the PCB ground plane. These minimize impedance and conduct heat away from the device. (Section 11.2).
- Other than ground vias, there are no (or only a few) vias underneath or closely around the device. This create a good, solid, ground plane.

H.2 Power supply decoupling

- The decoupling capacitors are all placed close to a supply pin (Section 11).
- The decoupling capacitors are spaced around the device (Section 11).
- The ground side of each decoupling capacitor has a direct path back to the center ground of the device.

H.3 PLL_AVDD

- The PLL_AVDD filter (especially the capacitor) is placed close to the PLL_AVDD pin (Section 11).

PRELIMINARY

I Associated Design Documentation

| Document Title | Information | Document Number |
|--|--|-----------------------|
| Estimating Power Consumption For XS1-L Devices | Power consumption | X4271 |
| Programming XC on XMOS Devices | Timers, ports, clocks, cores and channels | X9577 |
| xTIMEcomposer User Guide | Compilers, assembler and linker/mapper Timing analyzer, xScope, debugger Flash and OTP programming utilities | X3766 |

J Related Documentation

| Document Title | Information | Document Number |
|--|-------------------------------------|-----------------------|
| The XMOS XS1 Architecture | ISA manual | X7879 |
| XS1 Port I/O Timing | Port timings | X5821 |
| xCONNECT Architecture | Link, switch and system information | X4249 |
| XS1-L Link Performance and Design Guidelines | Link timings | X2999 |
| XS1-L Clock Frequency Control | Advanced clock control | X1433 |
| XS1-L Active Power Conservation | Low-power mode during idle | X7411 |

K Revision History

| Date | Description |
|------------|--|
| 2015-03-20 | Preliminary release |
| 2015-04-14 | Added RST to pins to be pulled hard, and removed reference to TCK from Errata Removed TRST_N references in packages that have no TRST_N |
| 2015-04-29 | VDDIOR and VDD (pins 47/48) switched - Section 3 |
| 2015-05-06 | Removed references tro DEBUG_N |
| 2015-07-09 | Updated electrical characteristics - Section 12 |
| 2015-08-27 | Updated part marking - Section 14 |



Copyright © 2015, All Rights Reserved.

Xmos Ltd. is the owner or licensee of this design, code, or Information (collectively, the "Information") and is providing it to you "AS IS" with no warranty of any kind, express or implied and shall have no liability in relation to its use. Xmos Ltd. makes no representation that the Information, or any particular implementation thereof, is or will be free from any claims of infringement and again, shall have no liability in relation to any such claims.